

GL-SD30 Users' Manual

Thank you for choosing the GL-SD30 series LED products. Please install and use the products according to the following directions to ensure normal functioning and proper operation of the products. If not to follow these instructions to properly install and normally use the products, you will not get the warranty-committed compensation or protection. GlacialLight will not take any responsibility for any product damage caused by improper installation or abnormal usage.



CAUTIONS

1. The warranty period will last for two years since your purchase of the products. If the product fails or malfunctions under the proper installation and normal usage within the warranty period, please send it back to our company with our RMA approval or contact your local distributors for free repairing and/or replacing services.
2. Please do not add/remove any electrical components to/from the products or change/tamper the original electrical design without our permission.
3. Please do not add/remove any mechanical components to/from the products or change/tamper the original mechanical design without our permission.
4. Please store or use the products in an environment that meets the temperature and humidity conditions designated by the product specifications. Please do not uncover the GL-SD30 series LED products, lest waterproof and dustproof become invalid.
5. To avoid any electrical shock or functional damage, please do not insert any foreign objects into the products.
6. For further information, please contact us.

CAUTION
CLASS 2 LED LIGHT
Do not stare at the beam.

Please be aware of
the correct DC
polarity before use.

Installation Steps

Installation procedure should be undertaken by qualified technical personnel.

1. Before installation, please turn off the power switch for the existing lamp.
2. Please make sure that both the DC voltage source and the power connector are compatible with the GL-SD30 series LED products. The DC voltage source may be provided by an AC adapter, a DC battery, and so on as long as it meets the specifications.
3. The GL-SD30 series LED products feed only on a DC voltage source having an appropriate output voltage designated by the product specifications. Please connect respectively the Brown (+) and Blue (-) wires/terminals at the rear side of the GL-SD30 series LED products to the Positive (+) and Negative (-) wires/terminals of the DC voltage source. It depends on the model in use that the Brown (+) and Blue (-) wires may be not screwed or screwed internally onto a terminal block. Misusing an inappropriate voltage source or reversing the correct voltage polarity may lead to product damage.
4. Please insulate properly the wires/terminals of the DC voltage source, screw tightly the GL-SD30 series LED products onto a wall or a stand, and adjust freely the lighting angle in accordance with individual needs.

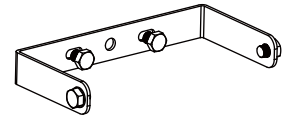
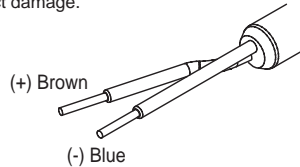
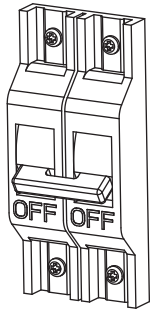

5. Please turn on the DC voltage source to check whether the GL-SD30 series LED products can work normally. If not, please check carefully whether all the above installation steps are taken and usage conditions are met.

Specifications

| Optical | | |
|---------------------------|-----------------------------|----------------------------|
| Model No. | GL-SD30-WW (Warm White) | GL-SD30-CW (Cool White) |
| CCT (Typical) | 3000 K | 6000 K |
| Luminous Flux (lm) | 1,350 lm | 1,900 lm |
| Typical Luminous Efficacy | 40 lm / W | 56 lm / W |
| CRI (Ra) | > 80 | > 75 |
| Beam Angle | 30° / 60° (Optional) | |
| Mechanical and Dimension | | |
| Outline Dim. | 313 x 223 x 92 (mm) | |
| Net. Weight | 3.5 (Kgs) | |
| Cover | Clear | |
| Electrical | | |
| Typical Power consumption | 34 W | |
| Input Voltage | 11-15V DC / 22-30V DC | |
| Input Current (Max.) | 4A at 11V DC / 2A at 22V DC | |
| Temperature Condition | | |
| Operating Temperature | -20 °C – +40 °C | |
| Storage Temperature | -40 °C – +85 °C | |

GL-SD30 Outlook

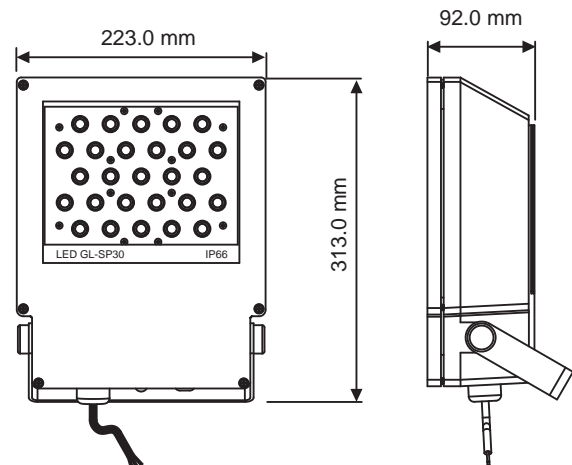

Candle Power Distribution Curve(30W/3M)

SD30-CW 30°

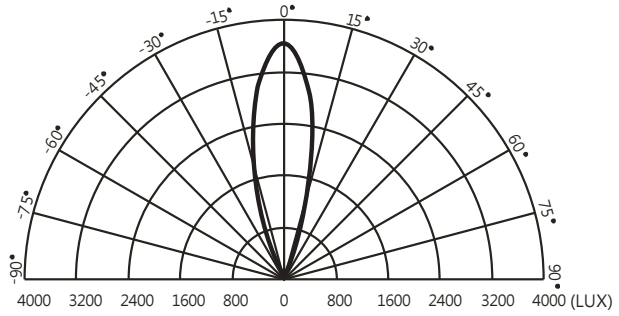
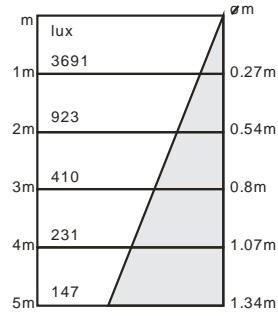

SD30-CW 60°

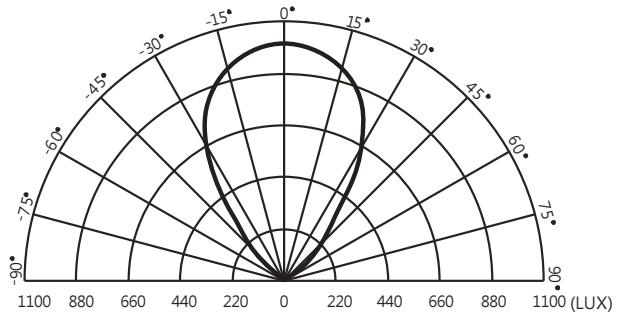
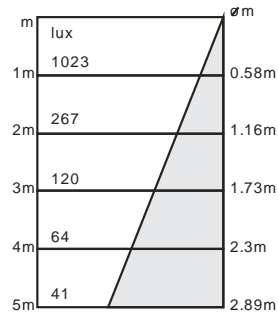

SD30-WW 30°

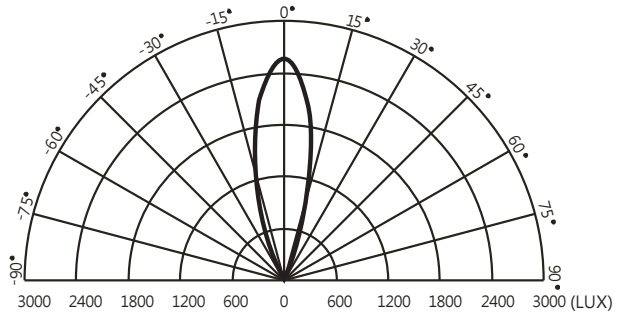
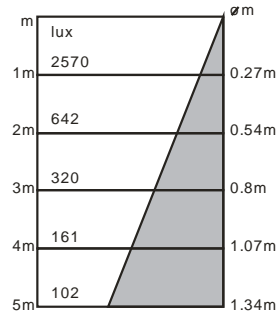

SD30-WW 60°

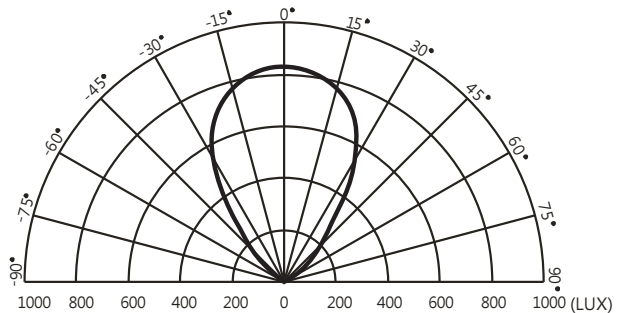
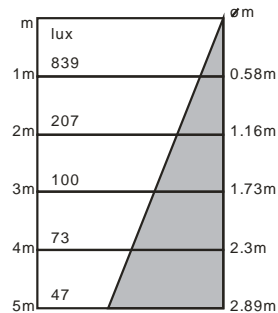

All rights reserved. All brand names and trademarks are the properties of their respective owners. The specifications are subject to change without notice.

17-SD30S000001

