

GL-EM01F-700

緊急照明系統說明書 Emergency Backup Module User's Manual

Installation Guidelines / 安裝指南

- 1** GL-EM01F-700 Emergency Backup Module.
GL-EM01F-700 緊急備用模組。



- 2** Install GP LED driver.
安裝GP LED driver.

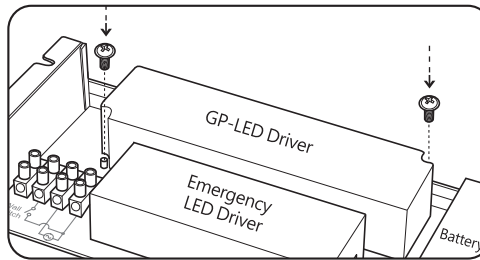

- 3** Connect L/N of GP LED driver to the terminal block.
將GP LED Driver 的L/N如圖鎖附於端子台上。

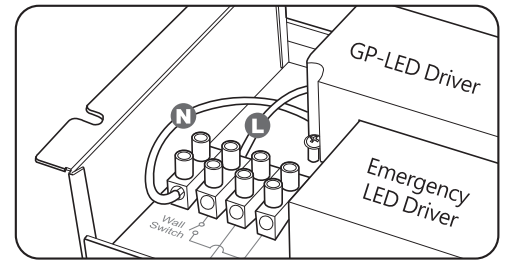

- 4** Attach GP LED driver DC output connector to Emergency Backup Module.
將GP LED driver DC output connector接到緊急備用模組。

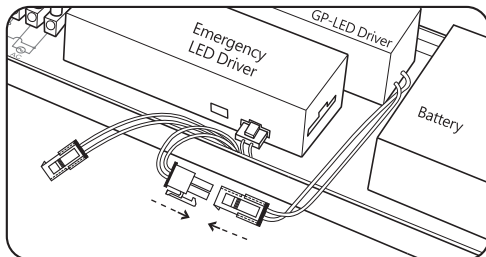

- 5** Attach Emergency Backup Module connector to the LED Panel Light connector.
將緊急備用模組的connector接到燈具的connector。

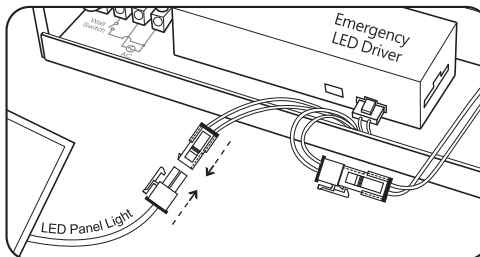

- 6** Attach battery connector to the emergency LED driver.
將電池的connector接到emergency LED driver.

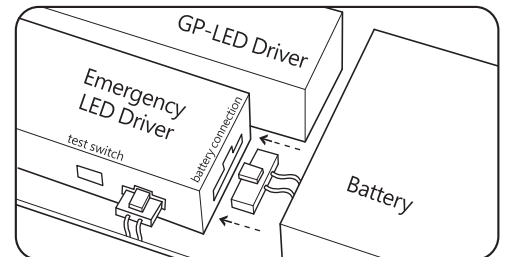

- 7** Connect TEST SWITCH to the emergency LED driver.
將TEST SWITCH線·接到Emergency LED driver.

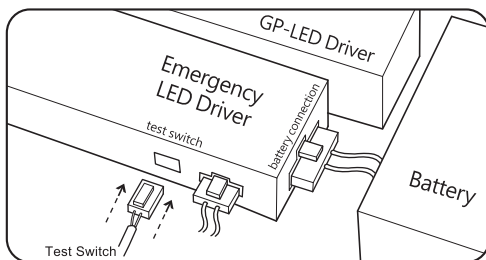

- 8** Emergency Backup Module connects to wall switch and AC source.
接開關及AC電源線。

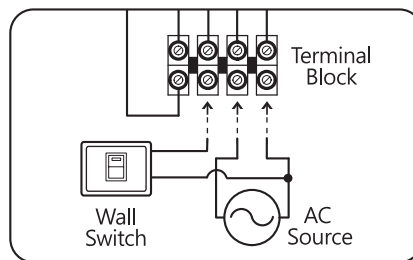

- 9** Place Emergency Backup Module on the back of LED Panel Light.
將緊急備用模組反過來平放在燈具背面·即完成安裝

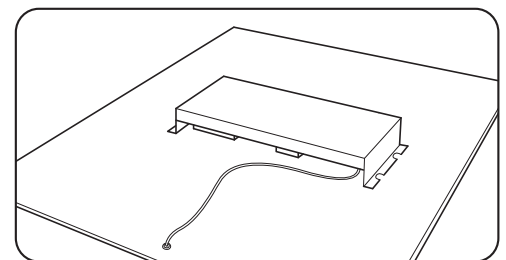

Wiring Diagrams / 接線圖

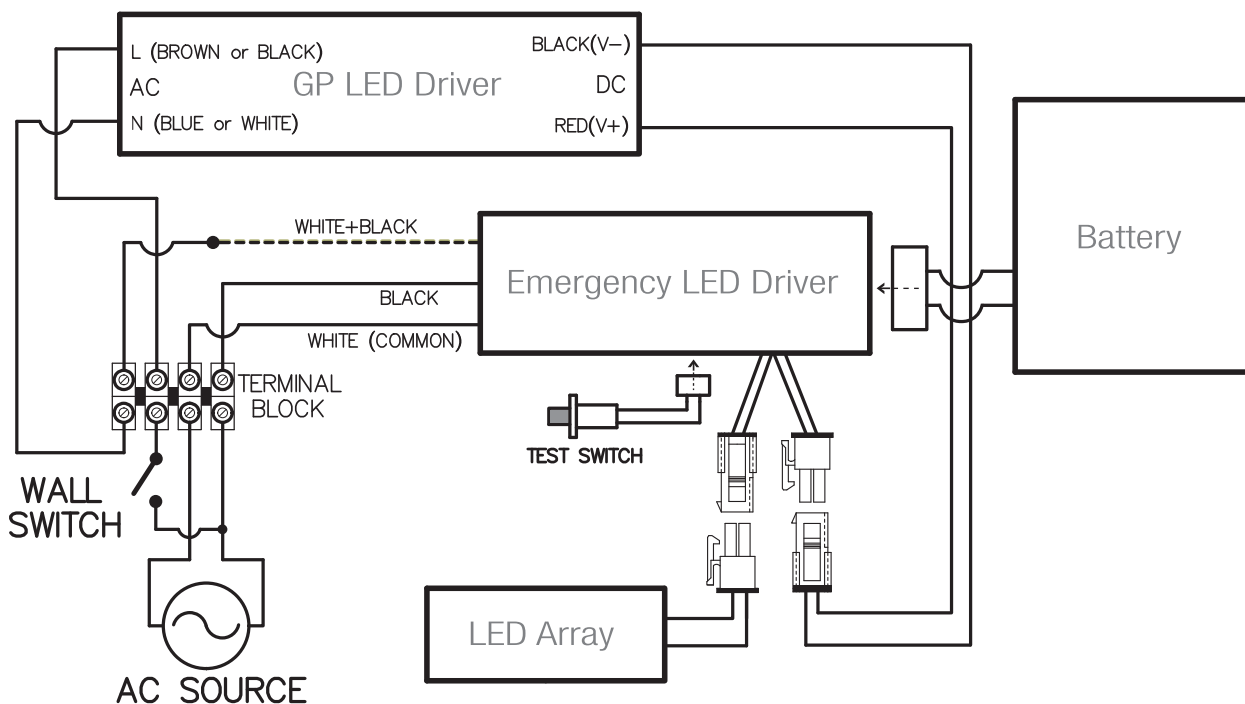

GL-EM01F-700 緊急照明系統說明書

Emergency Backup Module User's Manual

Thank you for choosing the GL-EM01F-700 products. Please install and use the products according to the following directions to ensure normal function and operation. If you do not follow these instructions to properly install and use the GL-EM01F-700, you will not be eligible for warranty compensation or protection. We do not take any responsibility for product damage resulting from improper installation or abnormal usage.



感謝您選擇使用GL-EM01F-700緊急照明系統產品。請您依據下列說明指示來安裝本產品以確保本產品的正常運作。如您未按說明指示妥善安裝以及正常使用，您的產品將無法得到正常的保修補償。不正常的安裝與使用所造成的產品損壞，本公司具免責權利。

Instructions / 指示說明

To ease the installation process and ensure the optimal performance of the product, carry out the installation procedure in compliance with the following safety regulations.

- Unpack carefully and ensure there is no product damage during shipping. Should the product be found damaged during shipping, please return it to your supplier.
- Unless otherwise specified, never connect the device with any dimmer switch.
- All the electrical wiring necessary for the proper installation of the LED Panel Light is supposed to be conducted by qualified personnel to prevent electric shock or product damage.
- Avoid humidity. Should the LED Panel Light be moistened by any liquid or fluid that may conduct electricity, immediately disconnect it from the power source.
- In case of a malfunction, turn off the power source immediately. Never try to repair the LED Panel Light by yourself which may cause serious damage and void your warranty. Instead, contact your local dealer for technical assistance.
- Please recycle the package.

為了本產品安裝便利性與產品最佳表現，請遵照下列安全規定執行安裝。

- 小心地拆卸包裝並確認運送過程中產品無造成損害。若發現任何運送損害請退回給供應廠商。
- 除特別指定，勿將本產品連接至調光開關。
- 任何關於電氣特性的連接或安裝，請委由合格的施工人員進行，以避免人員或產品傷害。
- 任何因液體接觸造成本產品潮溼皆會有導電情況，請即刻移除電源。
- 萬一發生故障，請即刻關閉電源。切勿試圖逕行修復本產品否則將可能導致產品嚴重損壞與喪失保固。應聯絡您的經銷商尋求技術協助。
- 請回收包裝材料。

Lamp / 燈具使用注意事項

- Never touch the luminaire when it turns on or gets hot.
- Unless otherwise specified, never use LED luminaires in humid environments.
- Appropriate ambient temperature: 10 to 40°C.
- 燈具點亮或發熱時，請勿觸碰燈具。
- 除特別指定，不要將燈具安裝在潮溼的環境。
- 適合安裝的環境溫度為 10~40°C。

Troubleshooting / 故障排除

- One of the following problems may appear while you use the LED lamp.
 - * No light :
Check whether your LED lamp and all other accessories are properly fitted into the fixture adequately connected to the specified power source.
 - * Fixture Cleaning :
To optimize the light output, we recommend that you periodically clean the internal and external optical lenses as well as the reflection mirrors.
Only use a dry soft cloth, a dust brush or a vacuum cleaner and never use any liquid chemical cleaner or water to clean the lamp.
- 當你使用燈具時，可能會出現以下問題。
 - * 燈具不亮：
請檢查燈具的電源線是否適切地連接。
 - * 燈具清潔：
建議周期性地以乾軟布擦拭、塵刷或吸塵器清潔燈具，勿用水或化學液體清潔燈具。

CAUTIONS / 警告

- 1. If the external flexible cable or cord of this luminaire is damaged, it shall be exclusively replaced by the manufacturer or his service agent or a similar qualified person in order to avoid a hazard.**
- 2. Prior to installation, remove the AC power.**
 1. 如果燈具外部纜線有損壞，應當由製造商、代理商或符合資格的施工人員做更換，以避免危險。
 2. 安裝前，請確實關閉交流電源。



©2015 GlacialTech Inc. All rights reserved. All brand names and trademarks are the properties of their respective owners. The specifications are subject to change without notice. For further information please visit official website: www.GlacialLight.com

本說明書內容如有變更恕不另行通知。欲瞭解更多資訊，請參閱官方網站：www.GlacialLight.com



17-EM01F70001