



Features

- High system efficacy up to 115 lm/W.
- Stainless steel outdoor-ready mounting bracket features 360 degrees of adjustment vertically.
- Corrosion-resistant aluminum Outdoor Stake Light Bracket.
- 60 degree beam angle available, 40 and 120 degree beam angle are optional.
- IP66 rated rugged for outdoor use.
- Wide operating temperature range from -40°C to +50°C.



Specifications

Type	GL-FL15-WW	GL-FL15-NW	GL-FL15-CW
Energy Used	15W		
Rated Life	30,000 Hours		
Input Voltage	100-240V AC		
Power Factor (PF)	0.88 at 120V AC, 0.80 at 240V AC		
CCT (color)	3000K	4000K	5000K
Luminous Flux	1570 lm	1650 lm	1730 lm
System Efficacy	105 lm/W	110 lm/W	115 lm/W
CRI (Minimum)	80	80	80
Beam Angle	40° / 60° / 120°		
Dimension	125 x 125 x 88.4 mm		
IP Rating	IP66		
Operation Temperature	-40°C ~ +50°C		
Net Weight	1.2 kg (GL-FL15)		
Package	8 Boxes/Carton		

Outline / Dimension

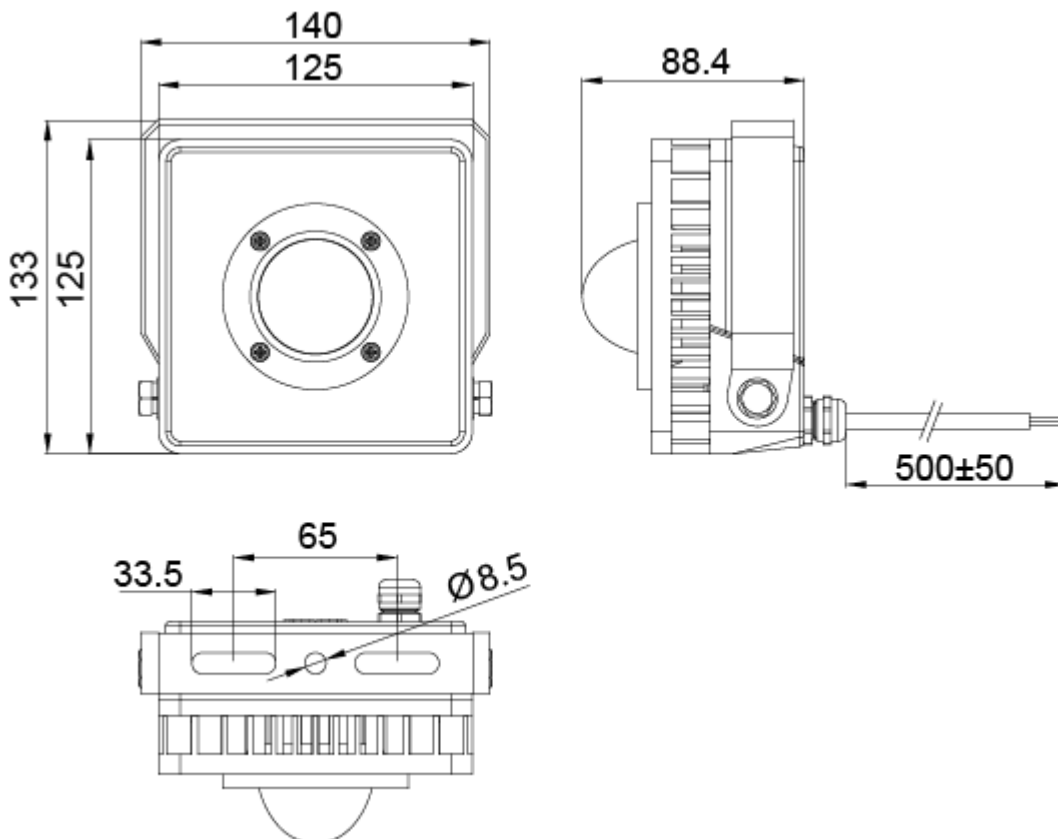

Luminous Intensity Distribution Diagram

GL-FL15-WW-40D / CCT : 3000K

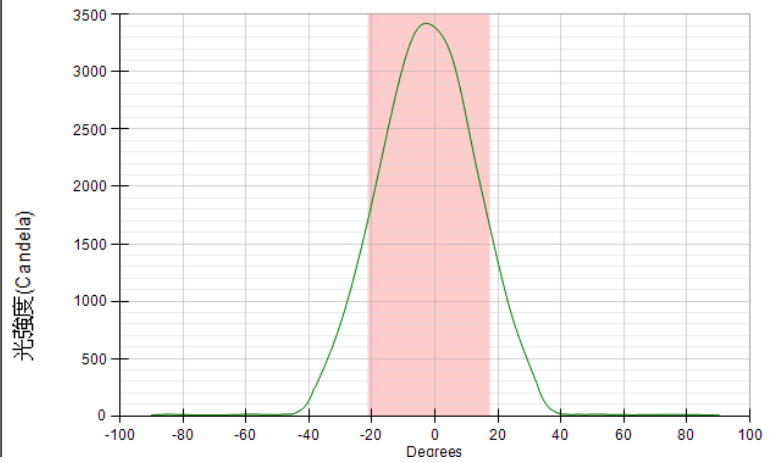
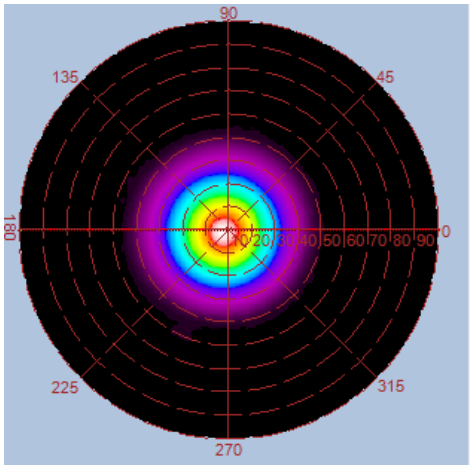
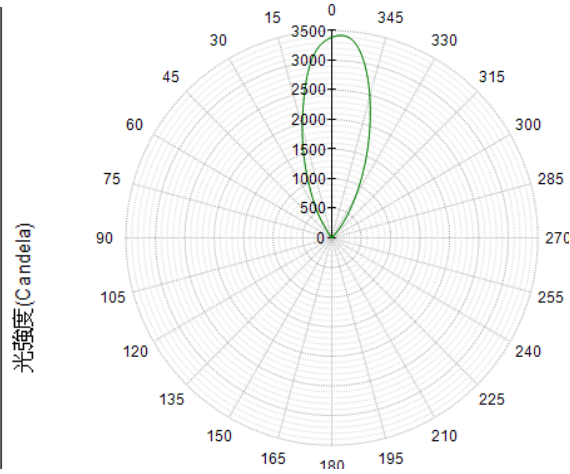
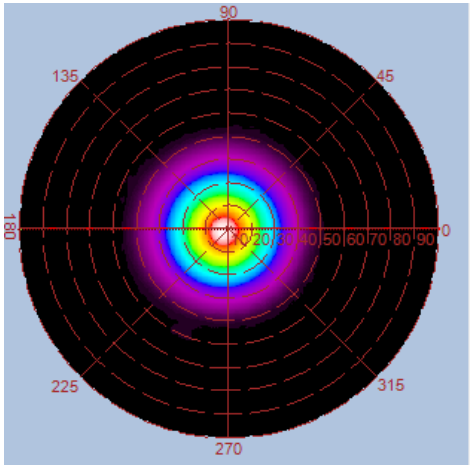

Height	E Avg.	E Max.	Diameter
1.0M	3052 Lx	4383 Lx	70 cm
2.0M	700 Lx	956 Lx	141 cm
3.0M	303 Lx	410 Lx	212 cm
4.0M	168 Lx	225 Lx	283 cm
5.0M	106 Lx	142 Lx	354 cm

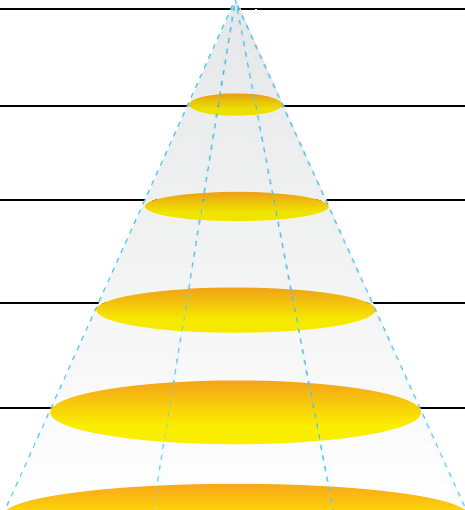

Luminous Intensity Distribution Diagram

GL-FL15-NW-40D / CCT : 4000K

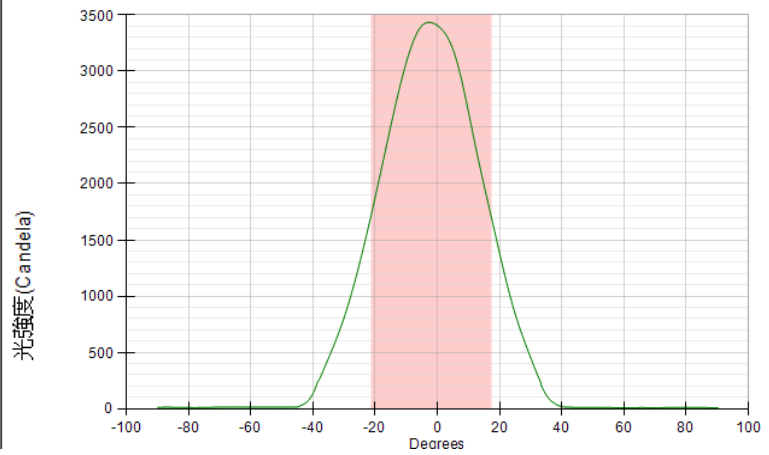
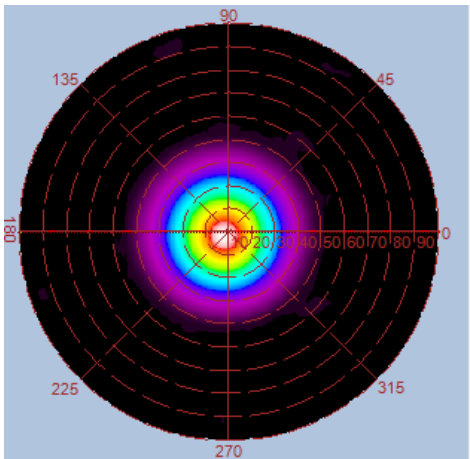
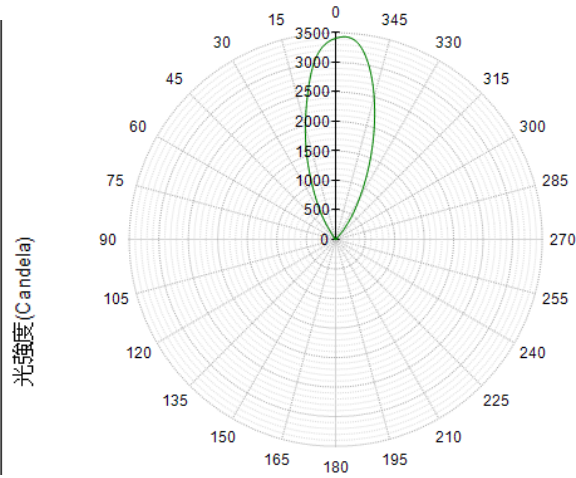
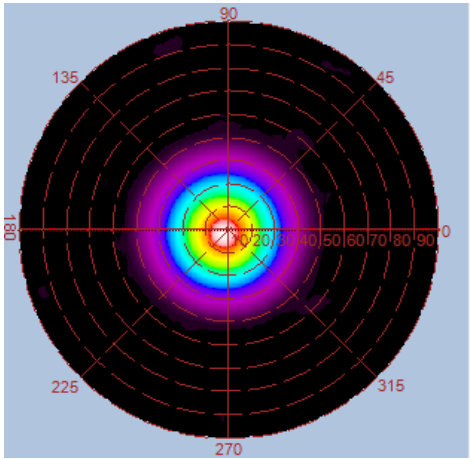

Height	E Avg.	E Max.	Diameter
1.0M	3074 Lx	4382 Lx	70 cm
2.0M	707 Lx	961 Lx	141 cm
3.0M	305 Lx	410 Lx	212 cm
4.0M	169 Lx	228 Lx	283 cm
5.0M	107 Lx	142 Lx	354 cm

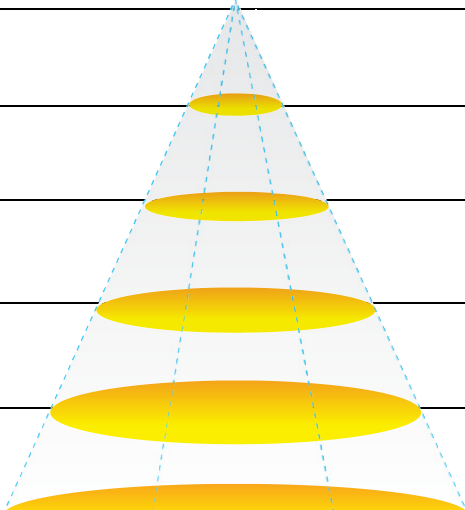

Luminous Intensity Distribution Diagram

GL-FL15-CW-40D / CCT : 5000K

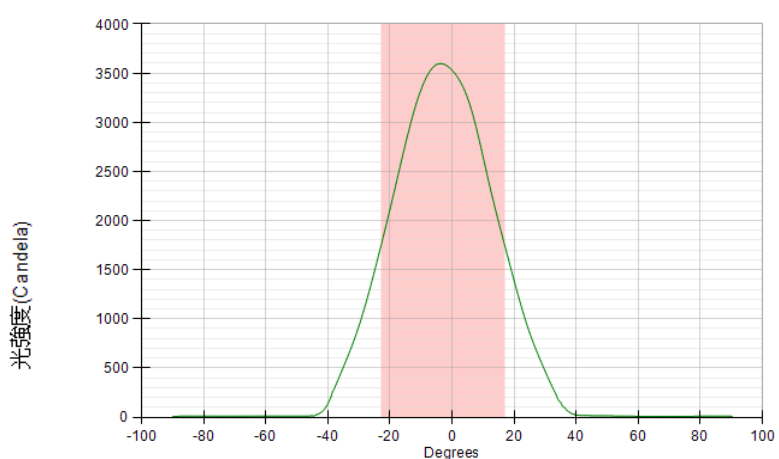
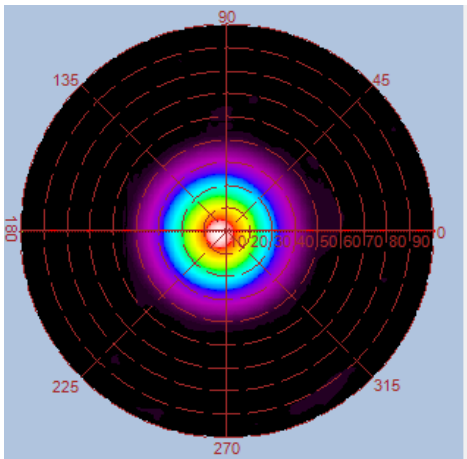
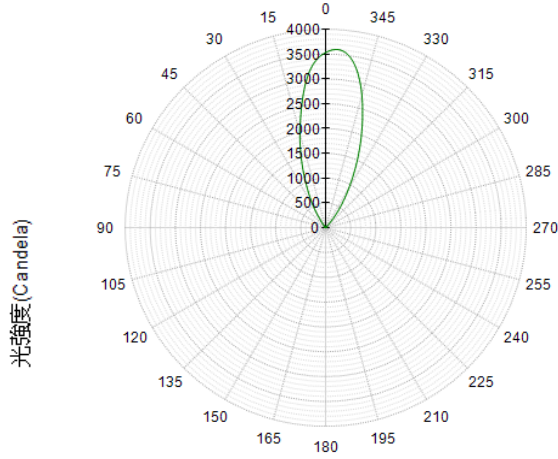
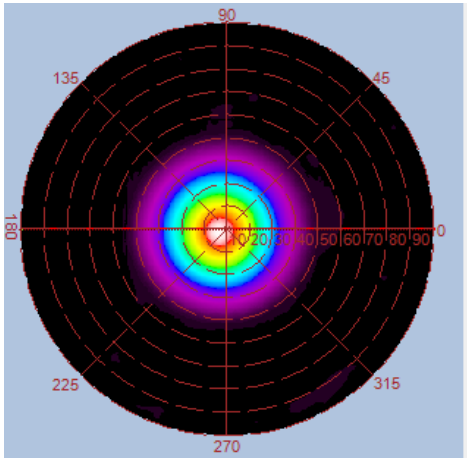

Angle= 40 Deg

Height	E Avg.	E Max.	Diameter
1.0M	3169 Lx	4571 Lx	72 cm
2.0M	730 Lx	997 Lx	145 cm
3.0M	315 Lx	427 Lx	218 cm
4.0M	175 Lx	236 Lx	291 cm
5.0M	111 Lx	148 Lx	363 cm

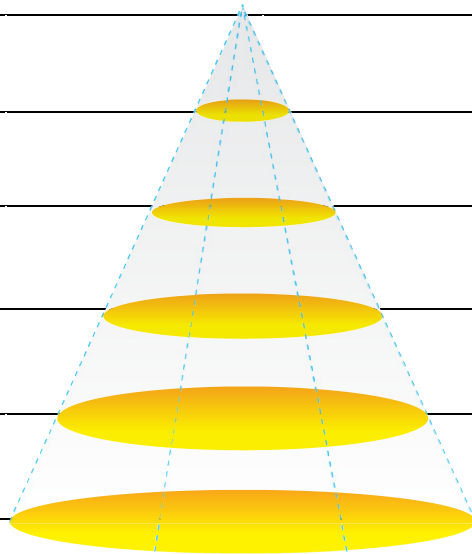

Luminous Intensity Distribution Diagram

GL-FL15-WW-60D / CCT : 3000K

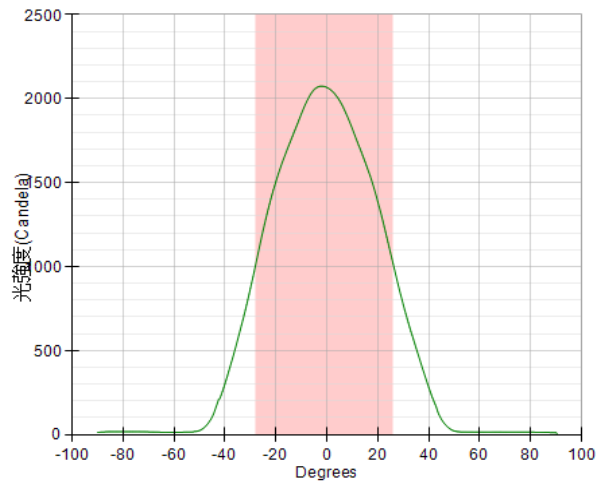
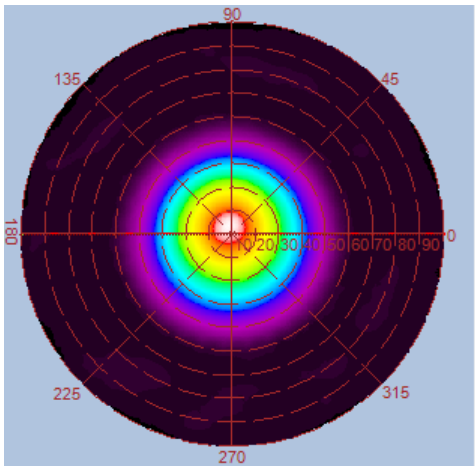
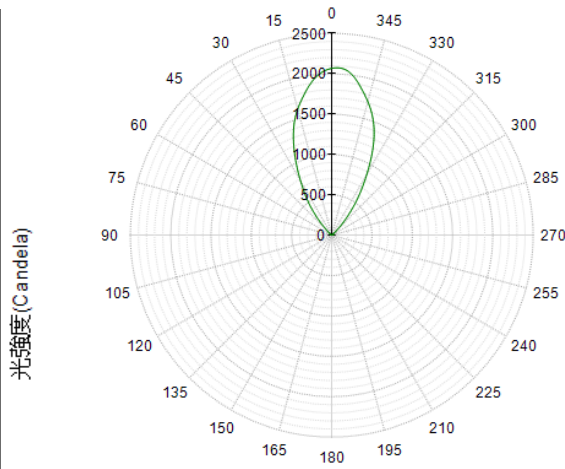
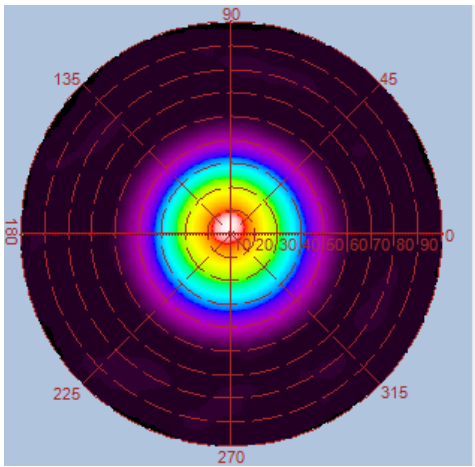

Height	E Avg.	E Max.	Diameter
1.0M	1737 Lx	2600 Lx	101 cm
2.0M	402 Lx	575 Lx	203 cm
3.0M	174 Lx	246 Lx	305 cm
4.0M	96 Lx	135 Lx	407 cm
5.0M	61 Lx	86 Lx	509 cm

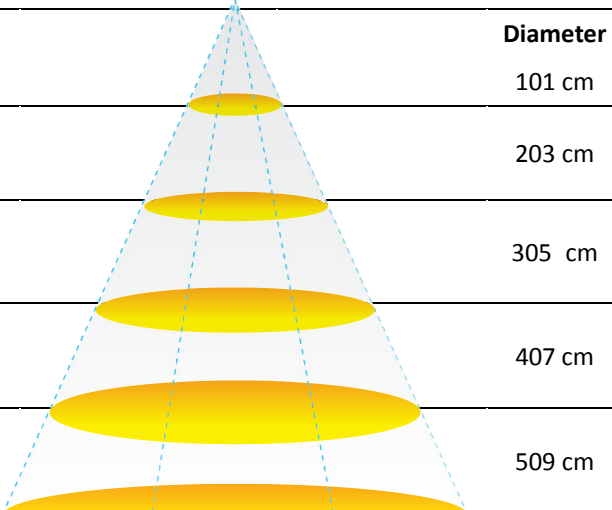

Luminous Intensity Distribution Diagram

GL-FL15-NW-60D / CCT : 4000K

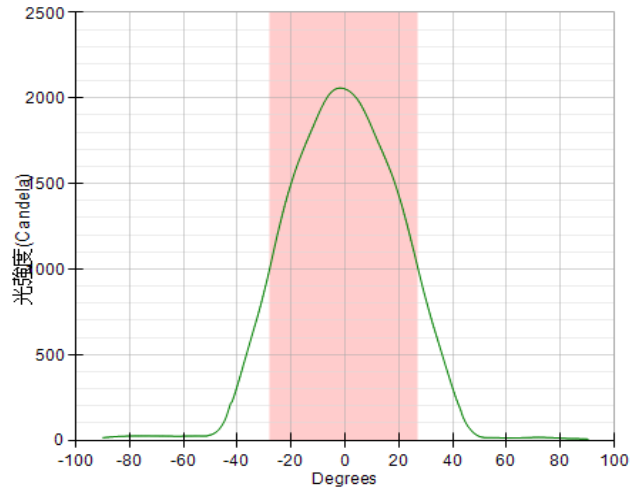
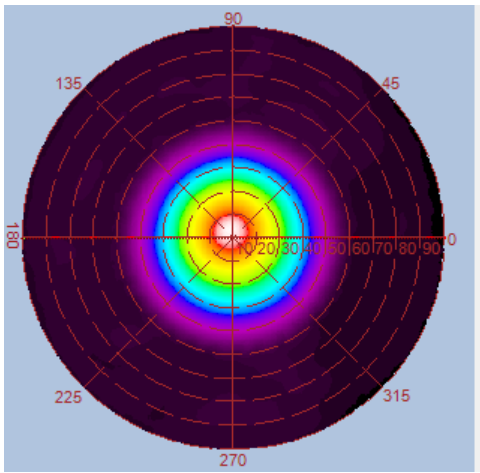
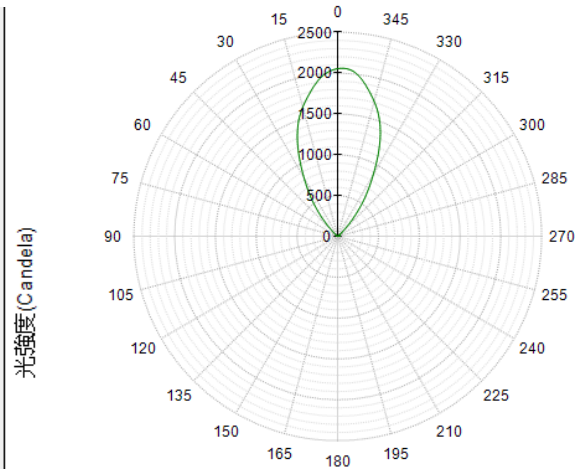
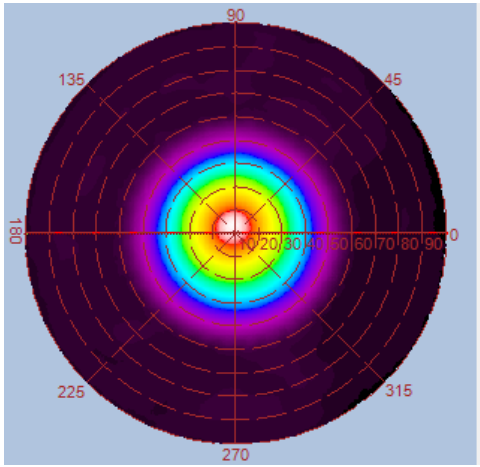

Height	E Avg.	E Max.	Diameter
1.0M	1717 Lx	2602 Lx	104 cm
2.0M	398 Lx	571 Lx	208 cm
3.0M	172 Lx	244 Lx	312 cm
4.0M	95 Lx	134 Lx	416 cm
5.0M	60 Lx	85 Lx	520 cm

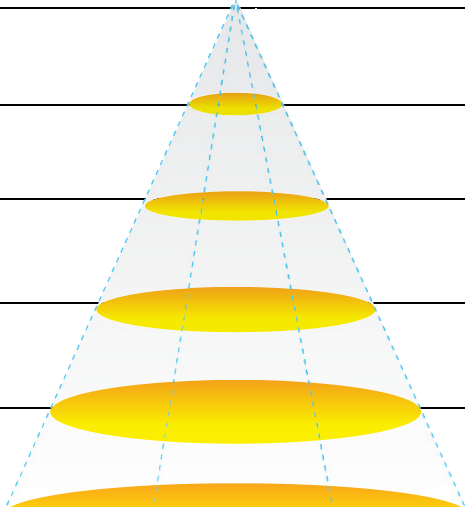

Luminous Intensity Distribution Diagram

GL-FL15-CW-60D / CCT : 5000K

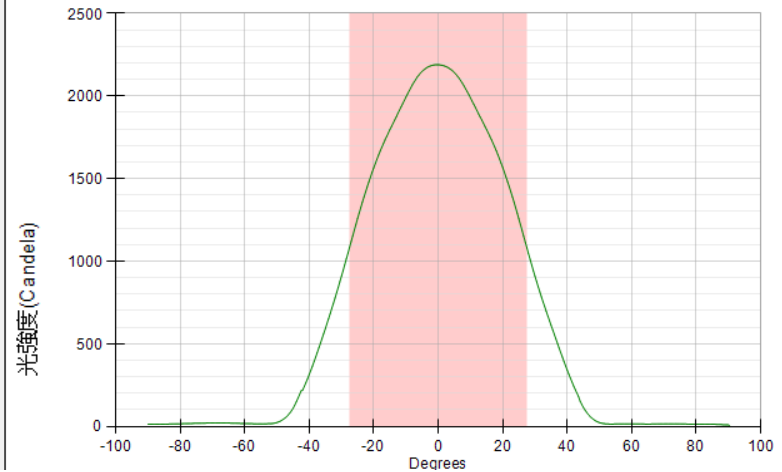
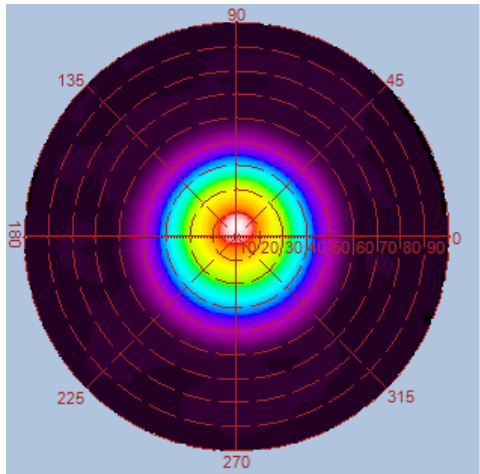
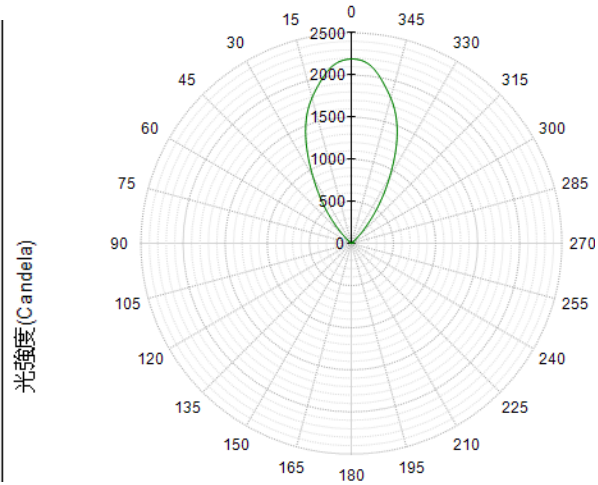
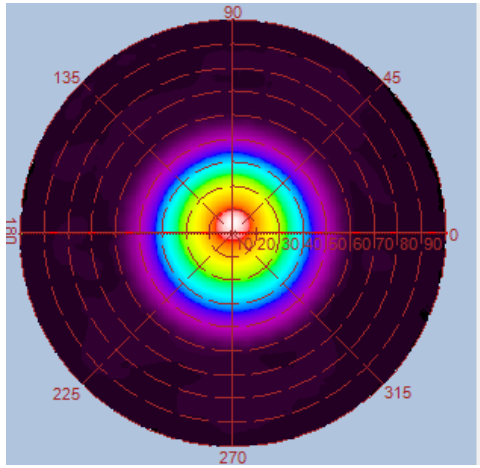

Height	E Avg.	E Max.	Diameter
1.0M	1833 Lx	2775 Lx	104 cm
2.0M	424 Lx	604 Lx	208 cm
3.0M	184 Lx	259 Lx	312 cm
4.0M	102 Lx	145 Lx	416 cm
5.0M	65 Lx	90 Lx	520 cm

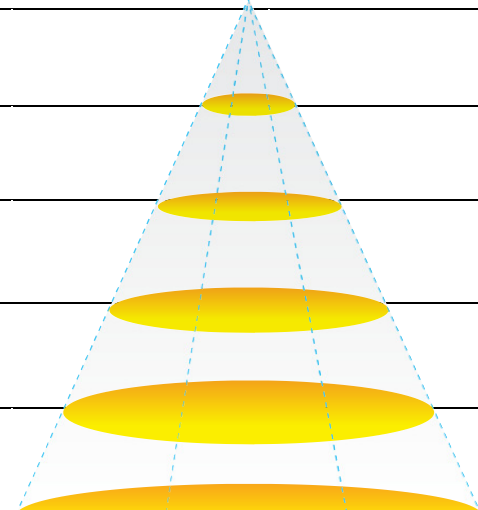

Luminous Intensity Distribution Diagram

GL-FL15-WW-120D / CCT : 3000K

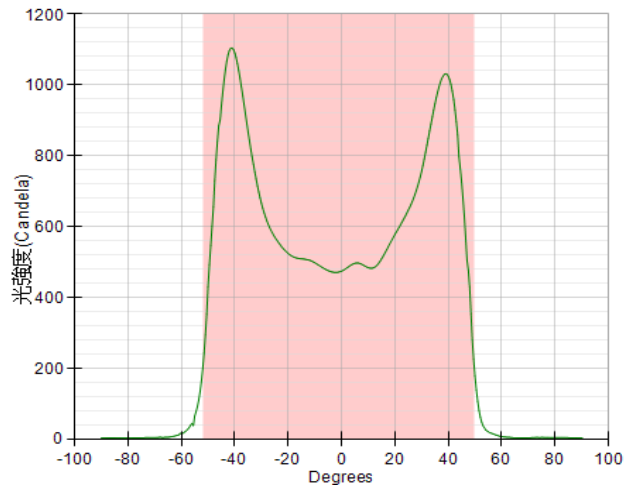
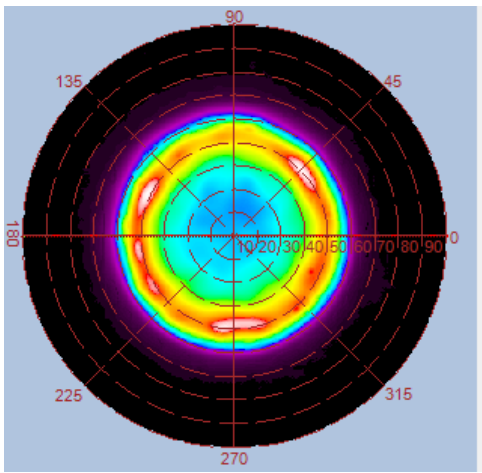
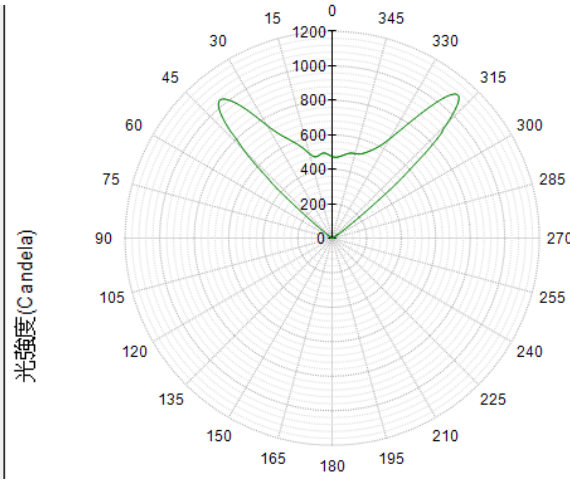
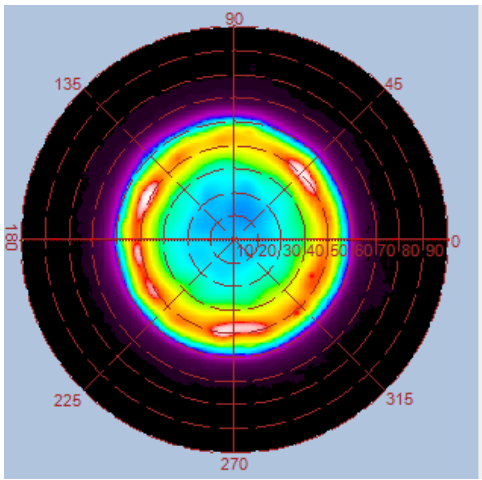

Height	E Avg.	E Max.	Diameter
1.0M	450 Lx	639 Lx	244 cm
2.0M	105 Lx	142 Lx	489 cm
3.0M	46 Lx	61 Lx	734 cm
4.0M	25 Lx	33 Lx	979 cm
5.0M	16 Lx	21 Lx	1223 cm

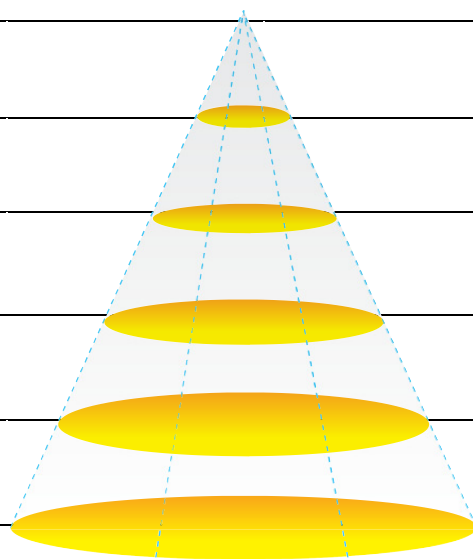

Luminous Intensity Distribution Diagram

GL-FL15-NW-120D / CCT : 4000K

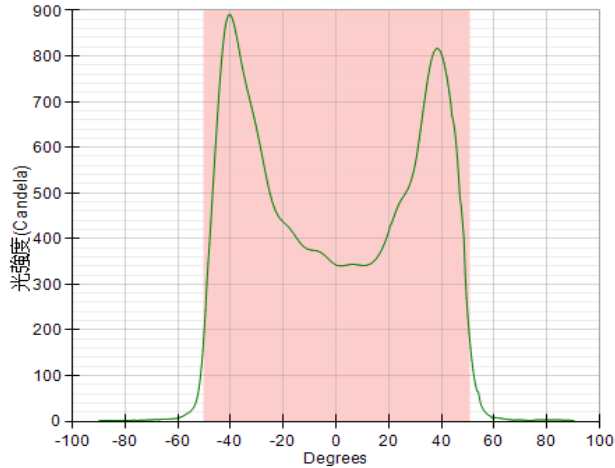
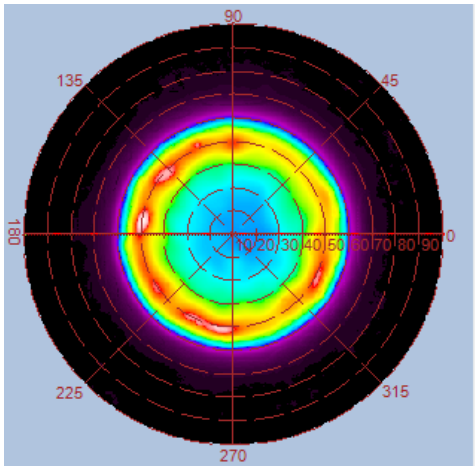
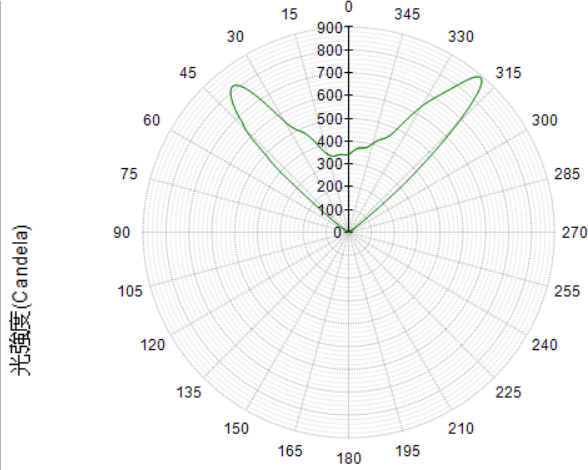
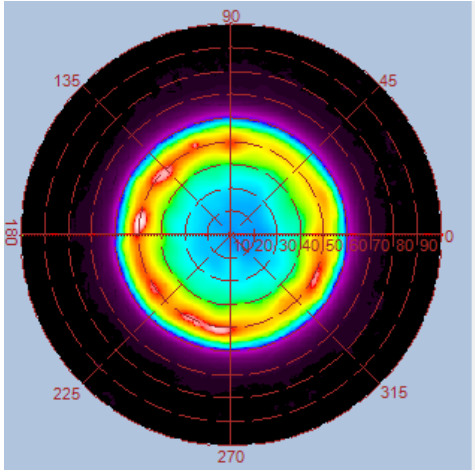

Height	E Avg.	E Max.	Diameter
1.0M	342 Lx	491 Lx	244 cm
2.0M	81 Lx	112 Lx	489 cm
3.0M	35 Lx	48 Lx	734 cm
4.0M	19 Lx	26 Lx	979 cm
5.0M	12 Lx	17 Lx	1223 cm

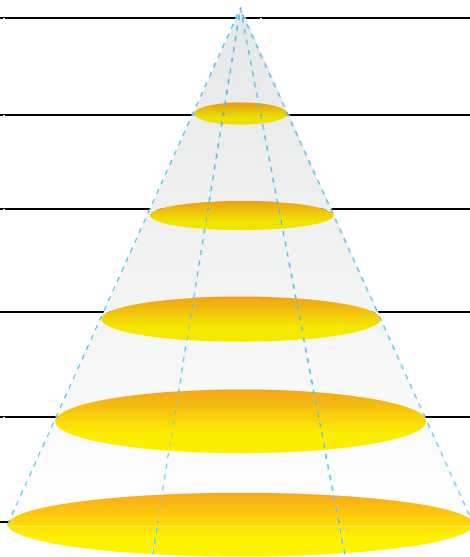

Luminous Intensity Distribution Diagram

GL-FL15-CW-120D / CCT : 5000K

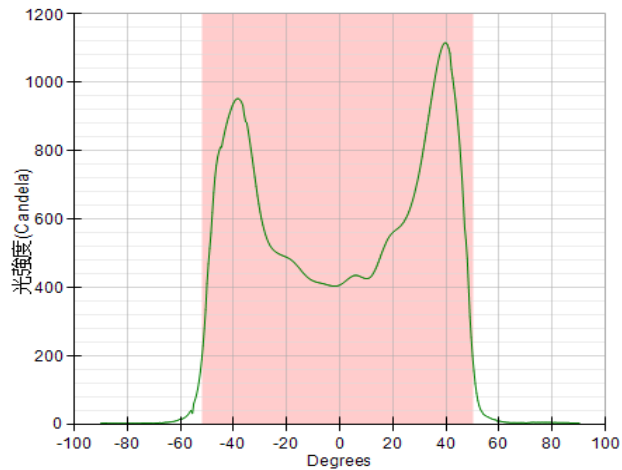
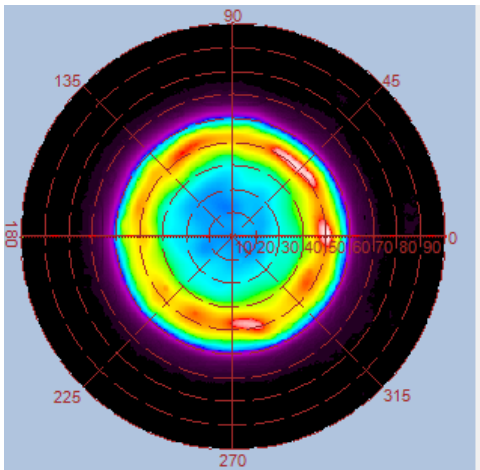
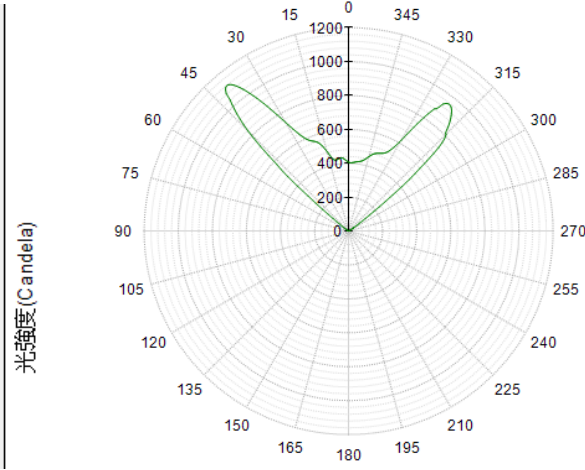
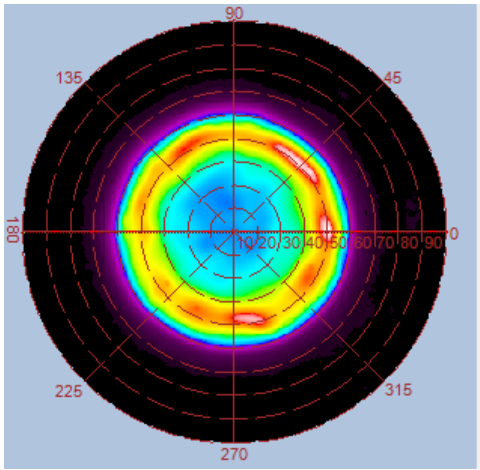

Height	E Avg.	E Max.	Diameter
1.0M	418 Lx	649 Lx	246 cm
2.0M	98 Lx	146 Lx	493 cm
3.0M	42 Lx	62 Lx	740 cm
4.0M	23 Lx	34 Lx	987 cm
5.0M	15 Lx	21 Lx	1234 cm

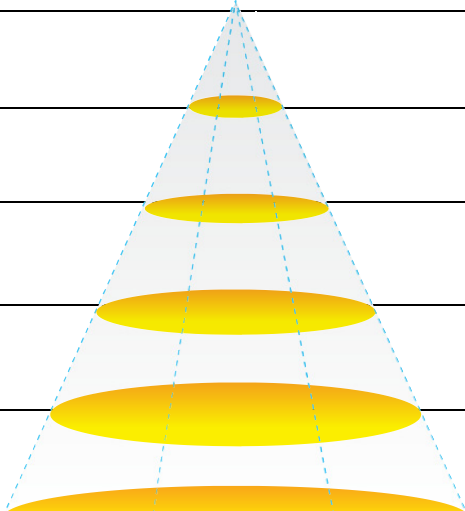

Gallery



* Outdoor Stake Light Bracket is Optional.