



Features

- For indoor or sheltered outdoor ceiling lighting applications
- Waterproof (IP64)
- All-in-one fixture
- Light flow smoothly fades around the edges of the fixture to create a special atmospheric effect
- DC input
- Slim, compact and fashionable design
- Bundled LED driver with Active PFC and OTP/SCP
- Very low power consumption
- No UV or IR radiation



Specifications

GL-DL08LD-IP (DC input)

Type	GL-DL08LD-IP-WW	GL-DL08LD-IP-NW	GL-DL08LD-IP-CW
Energy Used	16.4 W		
Rated Life	30,000 Hours		
Input Voltage	11-15V DC / 22-30V DC		
CCT (color)	3000K	4000K	6000K
Luminous Flux	1350 lm	1400 lm	1480 lm
System Efficacy	82 lm/W	85 lm/W	90 lm/W
CRI (Minimum)	80	80	80
Beam Angle	110°		
Dimension	Φ 208 x 20 mm		
IP Rating	IP64		
Operation Temperature	-20°C ~ +40°C		
Bundled Driver	GP-LD15-24C (Driver Output: Constant Current 700mA, 25V)		
Net Weight	600 g (with driver)		
Package	10 Boxes / Carton		
Fixture Hole	Φ 200 mm		

Outline / Dimension

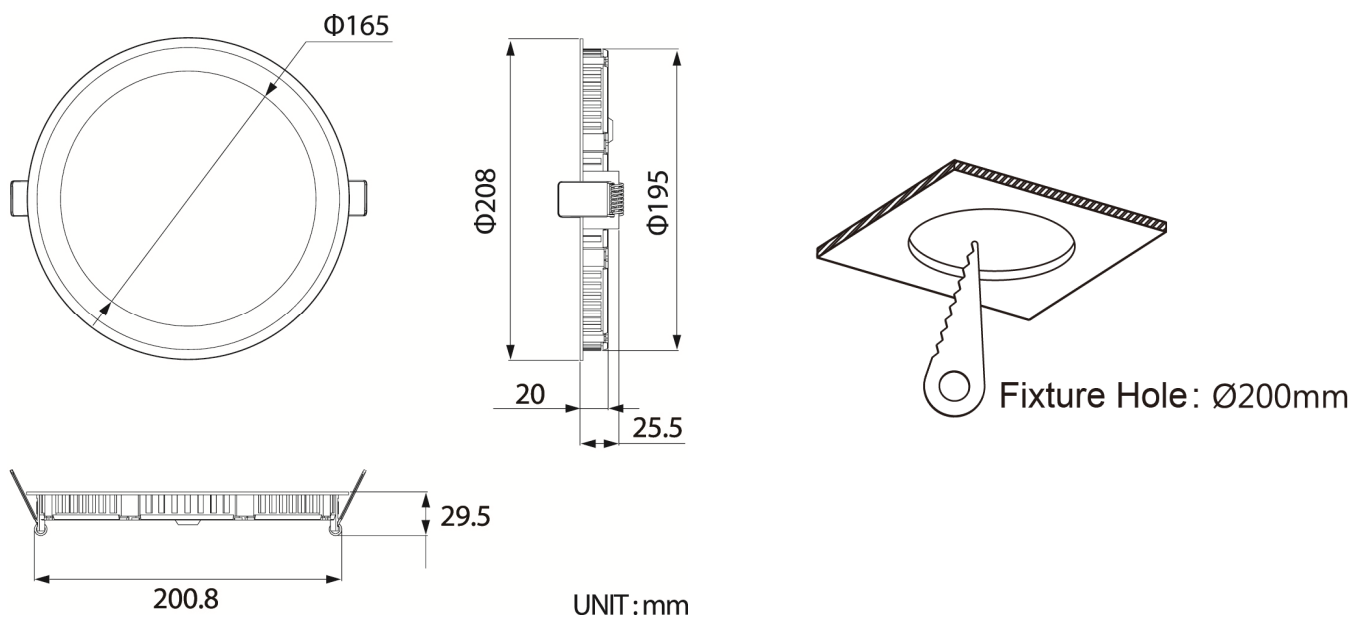

Luminous Intensity Distribution Diagram

GL-DL08-IP-WW/ CCT : 3000K

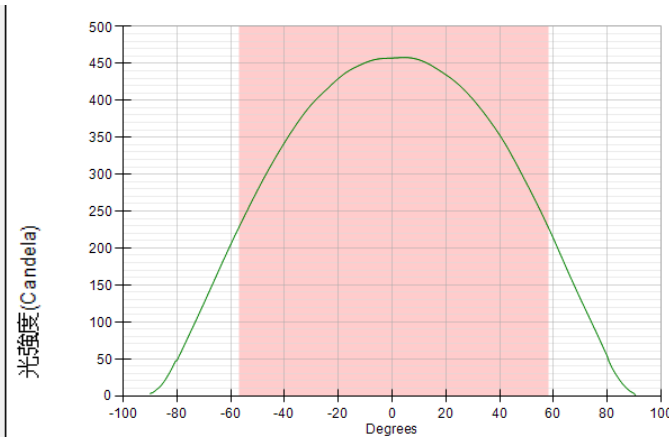
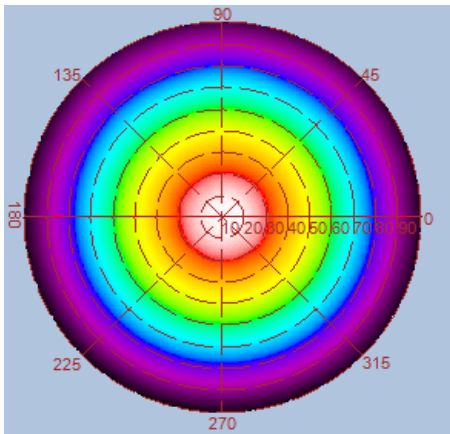
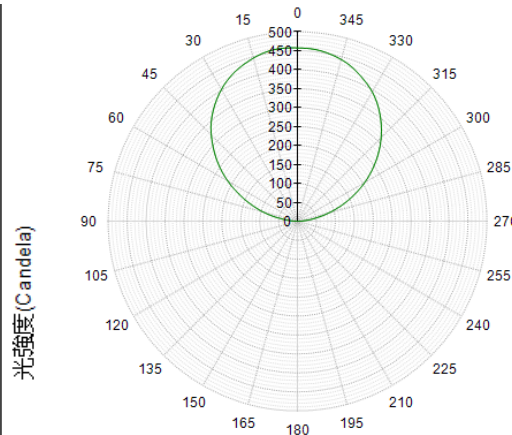
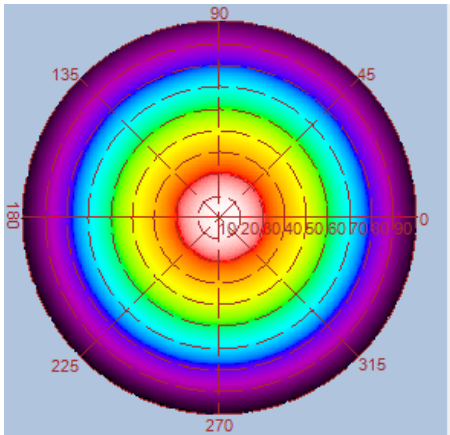

Height	E Avg.	E Max.	Diameter
1.0M	222 Lx	511 Lx	313 cm
2.0M	53 Lx	119 Lx	627 cm
3.0M	23 Lx	52 Lx	941 cm
4.0M	13 Lx	28 Lx	1255 cm
5.0M	8 Lx	18 Lx	1569 cm

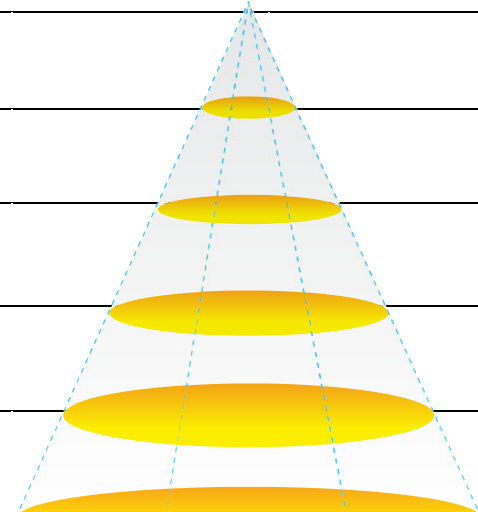

Luminous Intensity Distribution Diagram

GL-DL08-IP-NW / CCT : 4000K

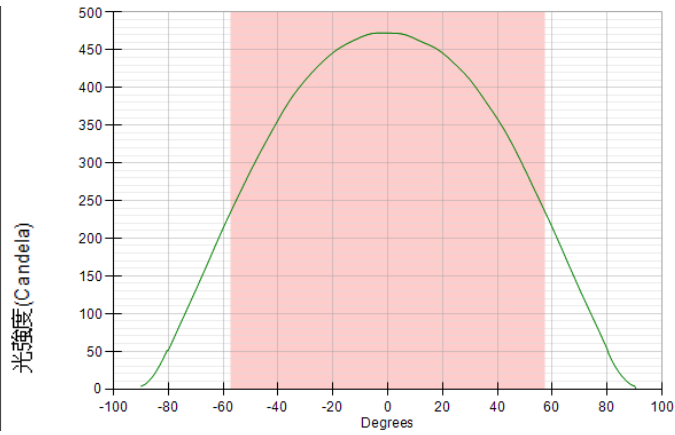
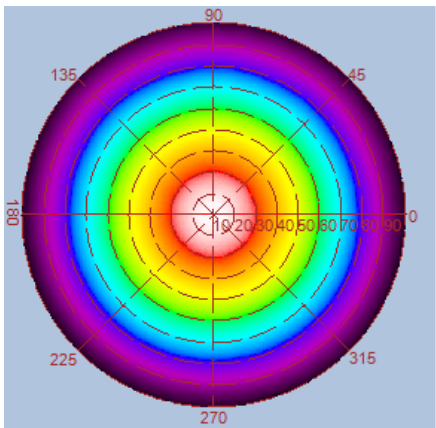
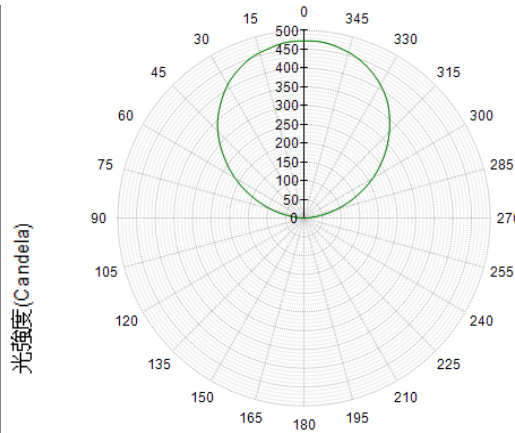
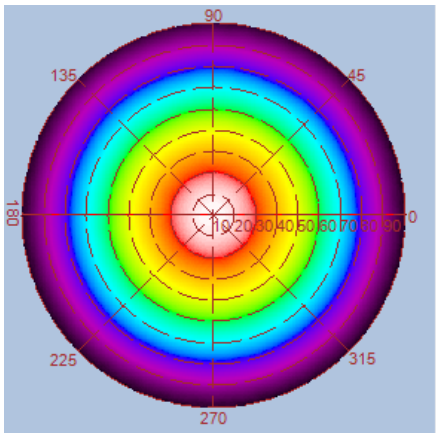

Height	E Avg.	E Max.	Diameter
1.0M	228 Lx	524 Lx	313 cm
2.0M	55 Lx	123 Lx	627 cm
3.0M	24 Lx	53 Lx	941 cm
4.0M	13 Lx	29 Lx	1255 cm
5.0M	8 Lx	18 Lx	1569 cm

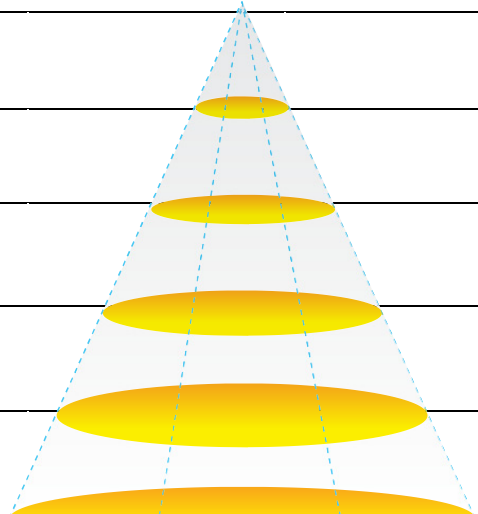

A diagram of a light cone with yellow ellipses representing light distribution at different heights. The cone is shown in perspective, with a dashed blue outline. The ellipses are yellow and represent the light distribution at different heights. The diagram is positioned to the right of the table.

Luminous Intensity Distribution Diagram

GL-DL08-IP-CW/ CCT : 6000K

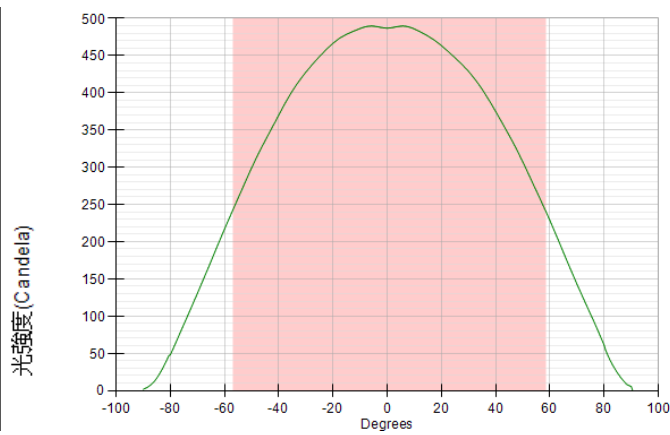
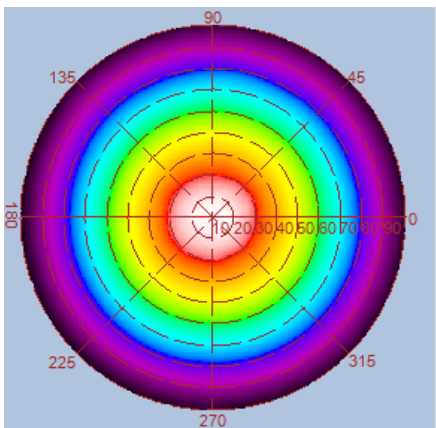
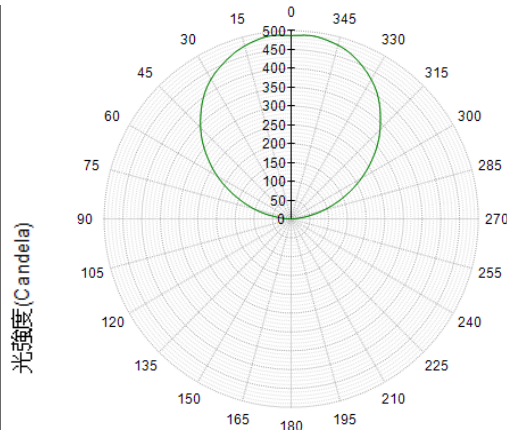
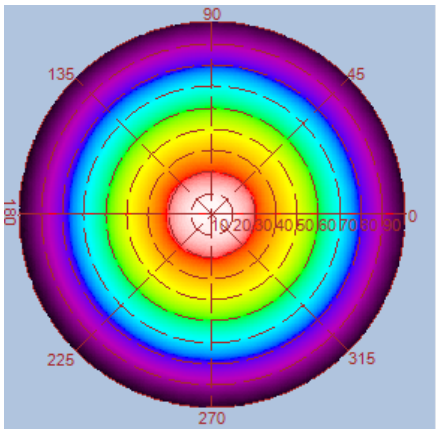

Height	E Avg.	E Max.	Diameter
1.0M	235 Lx	540 Lx	316 cm
2.0M	56 Lx	126 Lx	633 cm
3.0M	24 Lx	55 Lx	950 cm
4.0M	13 Lx	30 Lx	1267 cm
5.0M	8 Lx	19 Lx	1584 cm

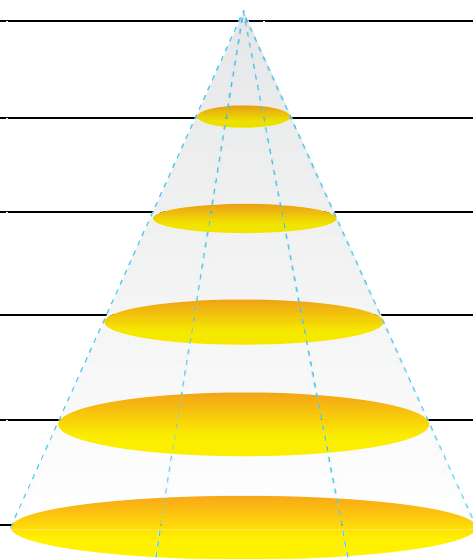

Outline / Dimension

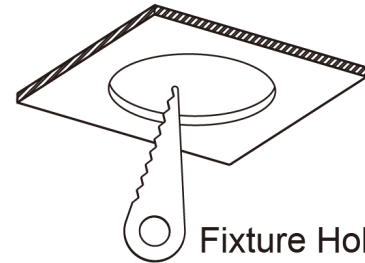
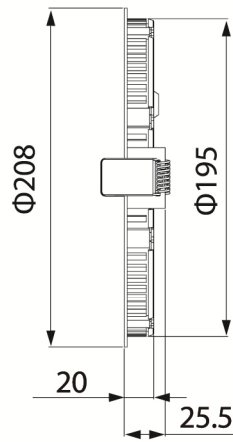
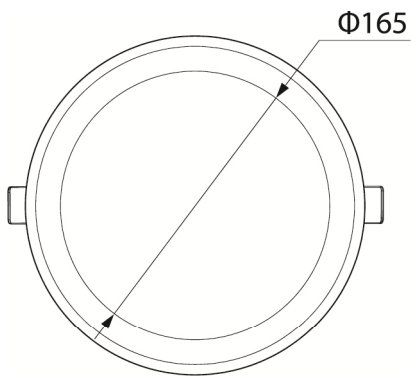

Fixture Hole: Ø200mm

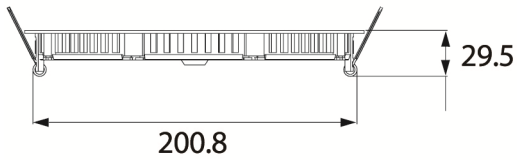

UNIT: mm

