



Features

- Can rotate 360° horizontally and 90° vertically.
- Up to 2800 lumens using just 30W.
- Efficient cold forged thermal design.
- Free of projected heat and UV radiation.
- CRI 80 standard for accurate color rendering and CRI 90 or 95 models available.
- Dimming available.(GL-TSL30DA-B)



Specifications

(non-dimmable)

Type	GL-TSL30-B-WW	GL-TSL30-B-NW	GL-TSL30-B-CW
Energy Used	30W		
Rated Life	30,000 Hours		
Input Voltage	100-240V AC (Driver with CUL Certificate Support 277V AC for North America only)		
Power Factor (PF)	0.97 at 120V AC, 0.93 at 240V AC		
CCT (color)	3000K	4000K	5000K
Luminous Flux	2600 lm	2750 lm	2800 lm
System Efficacy	87 lm/W	92 lm/W	93 lm/W
CRI (Minimum)	80	80	80
Beam Angle	20° / 38°		
Dimension	Φ 132 x 252 mm		
Operation Temperature	-20°C ~ +40°C		
Net Weight	1.25 kg (with driver)		
Package	6 Boxes / Carton		

(DC dimmable: 1-10V/PWM/Resistor)

Type	GL-TSL30DA-B-WW	GL-TSL30DA-B-NW	GL-TSL30DA-B-CW
Energy Used	30W		
Rated Life	30,000 Hours		
Input Voltage	100-240V AC (Driver with CUL Certificate Support 277V AC for North America only)		
Power Factor (PF)	0.97 at 120V AC, 0.93 at 240V AC		
CCT (color)	3000K	4000K	5000K
Luminous Flux	2600 lm	2750 lm	2800 lm
System Efficacy	87 lm/W	92 lm/W	93 lm/W
CRI (Minimum)	80	80	80
Beam Angle	20° / 38°		
Dimension	Φ 132 x 252 mm		
Operation Temperature	-20°C ~ +40°C		
Net Weight	1.25 kg (with driver)		
Package	6 Boxes / Carton		

Luminous Intensity Distribution Diagram

GL-TSL30 -WW-20D / CCT: 3000K

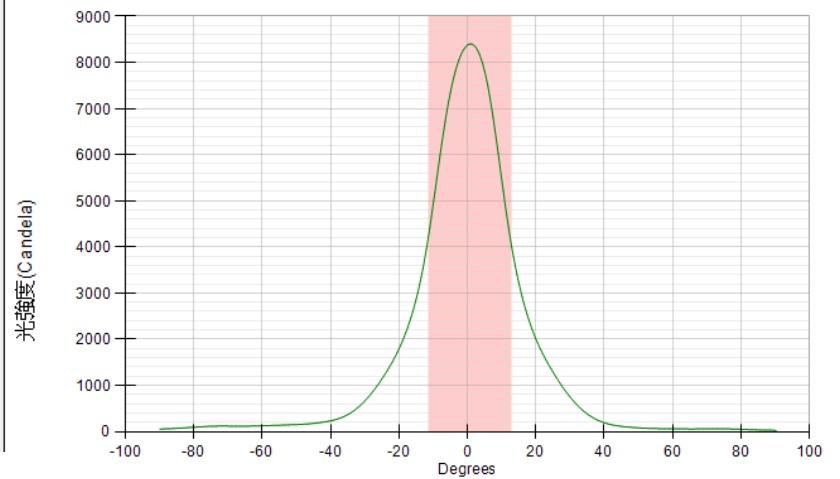
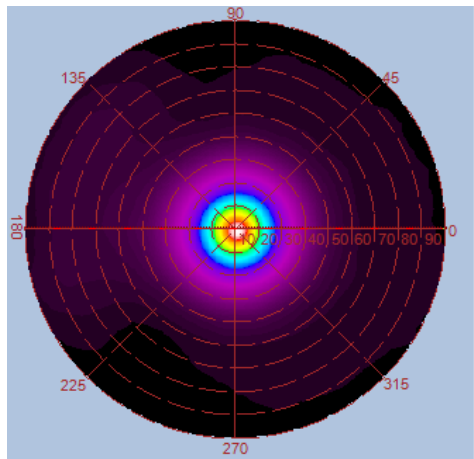
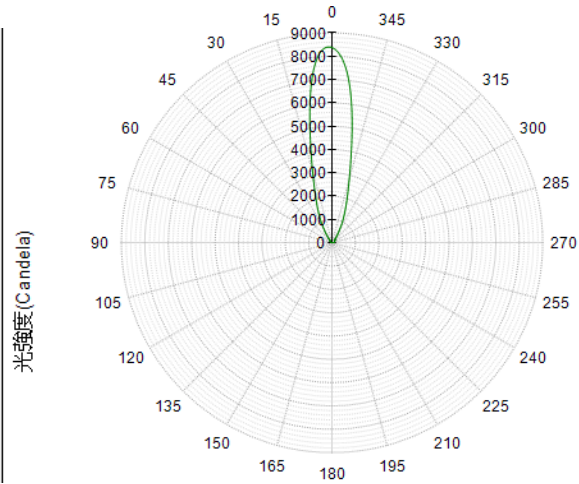
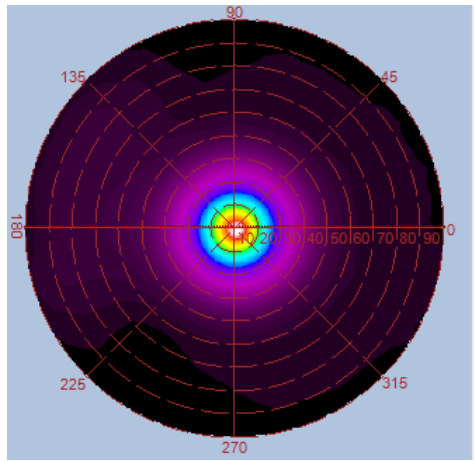

Height	E Avg.	E Max.	Diameter
1.0M	7407 Lx	10039 Lx	43 cm
2.0M	1779 Lx	2329 Lx	86 cm
3.0M	776 Lx	1002 Lx	130 cm
4.0M	433 Lx	561 Lx	173 cm
5.0M	273 Lx	351 Lx	217 cm

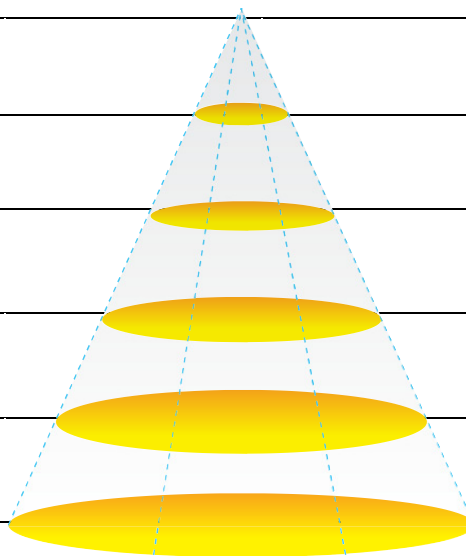

GL-TSL30 –NW-20D / CCT: 4000K

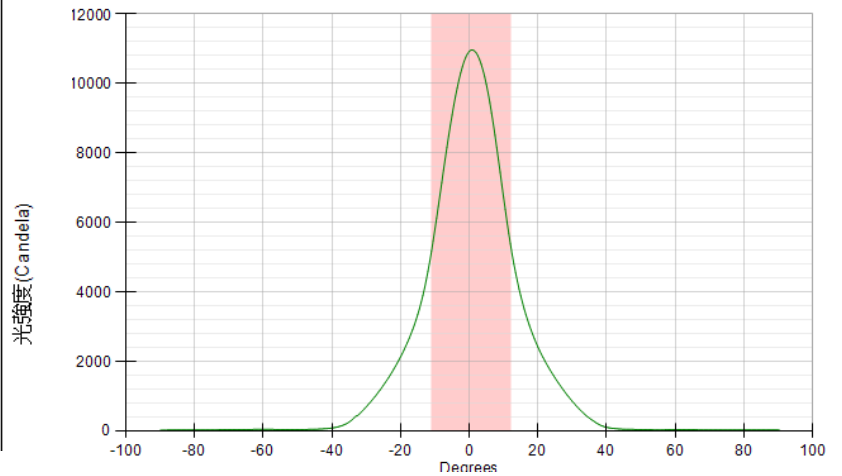
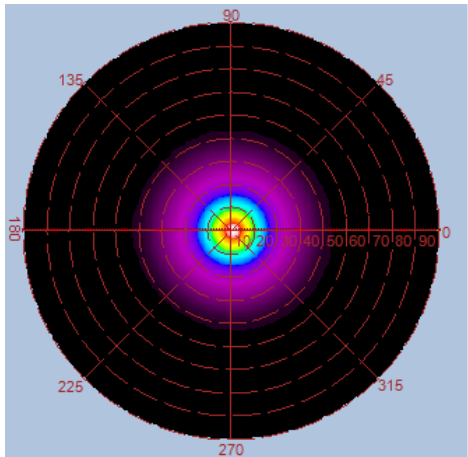
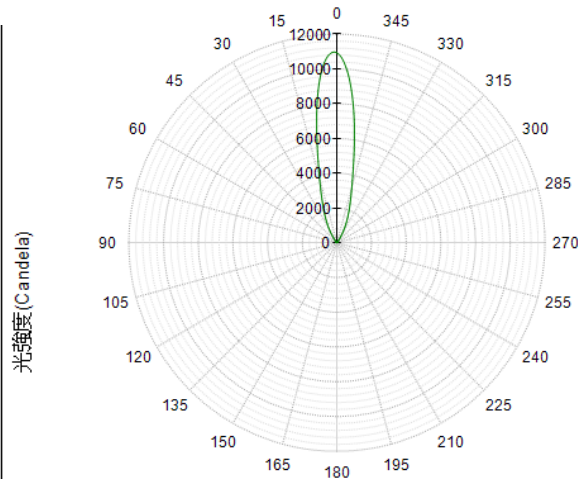
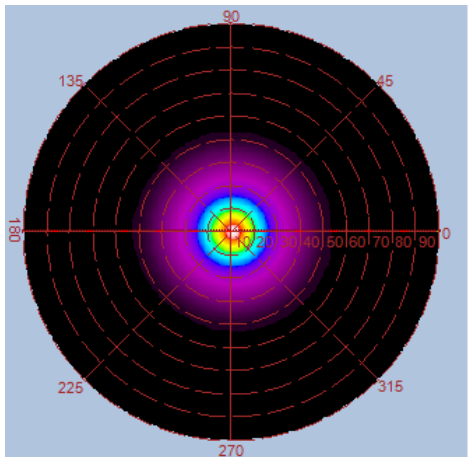

Height	E Avg.	E Max.	Diameter
1.0M	9370 Lx	12696 Lx	40 cm
2.0M	2276 Lx	3000 Lx	81 cm
3.0M	997 Lx	1299 Lx	122 cm
4.0M	559 Lx	728 Lx	162 cm
5.0M	355 Lx	460 Lx	203 cm

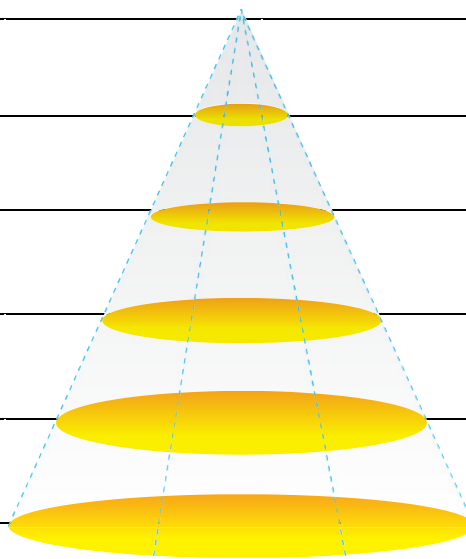

GL-TSL30 –CW-20D / CCT: 5000K

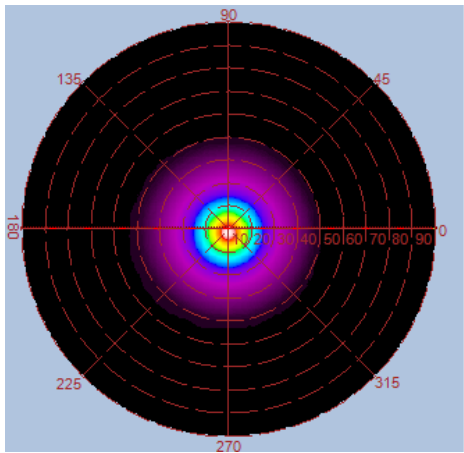

光強度 (Candela)

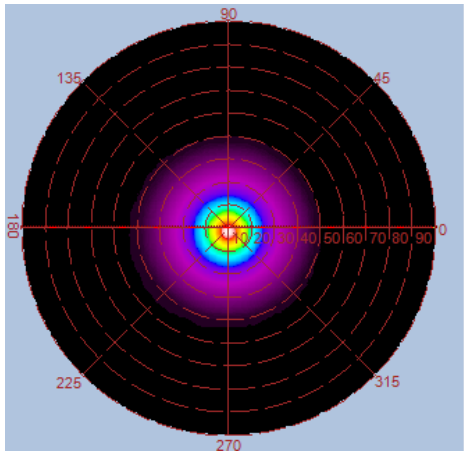
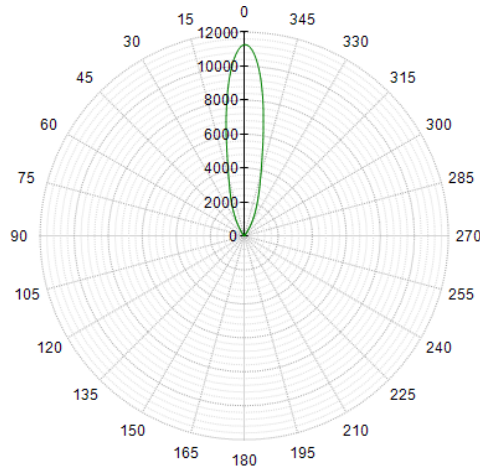

光強度 (Candela)

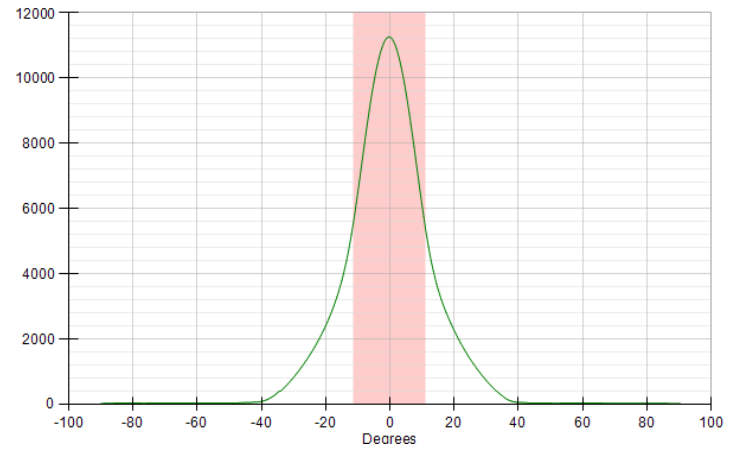

Height	E Avg.	E Max.	Diameter
1.0M	9500 Lx	12867 Lx	39 cm
2.0M	2309 Lx	3060 Lx	79 cm
3.0M	1018 Lx	1334 Lx	119 cm
4.0M	570 Lx	741 Lx	159 cm
5.0M	363 Lx	473 Lx	198 cm

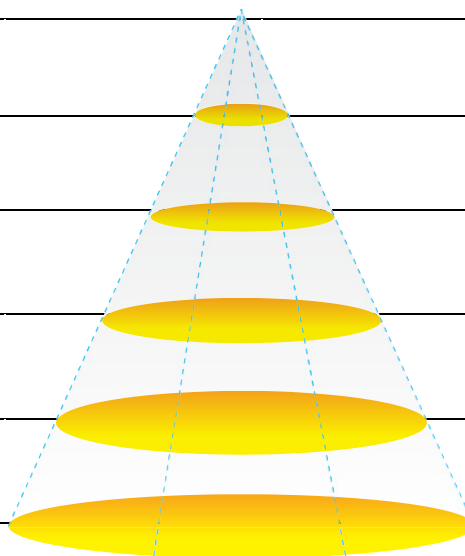

Luminous Intensity Distribution Diagram

GL-TSL30 –WW-38D / CCT: 3000K

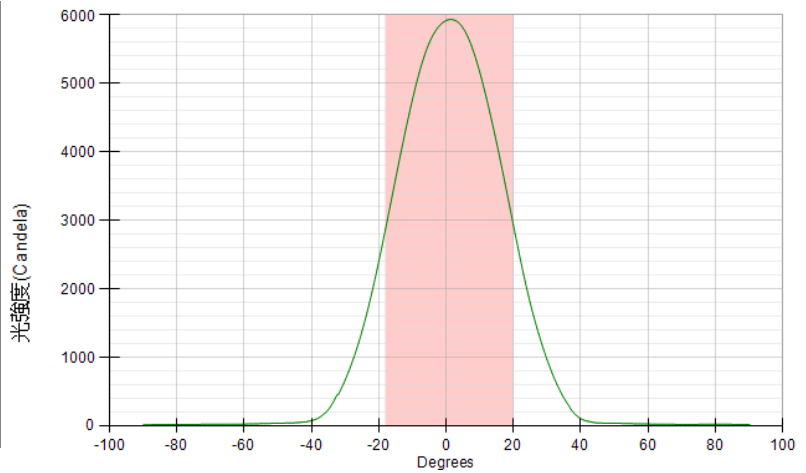
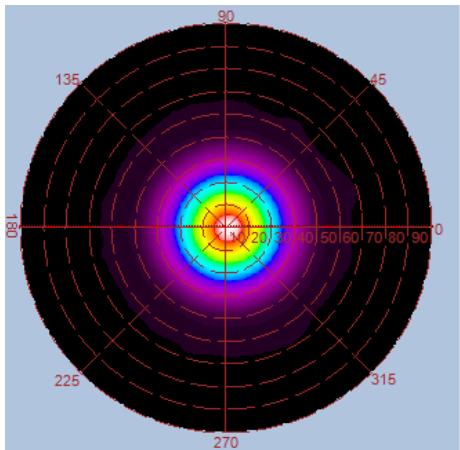
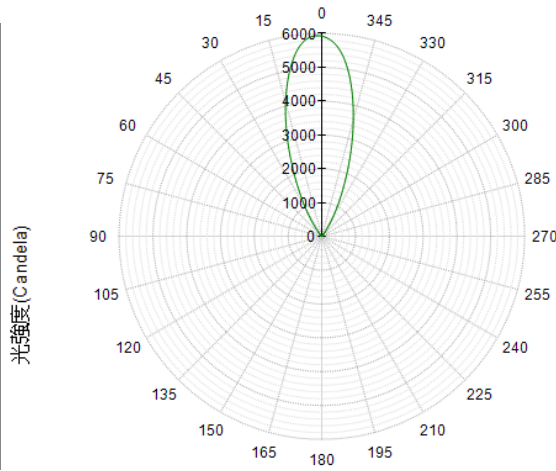
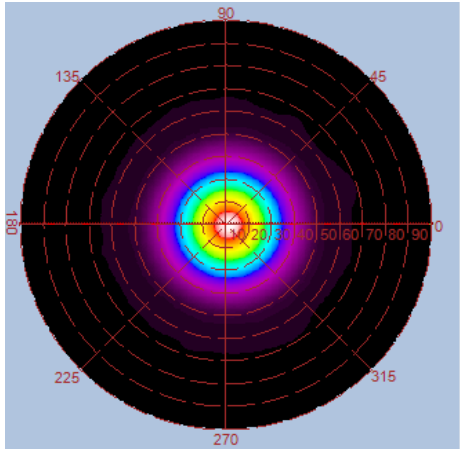

Height	E Avg.	E Max.	Diameter
1.0M	5012 Lx	6766 Lx	68 cm
2.0M	1198 Lx	1580 Lx	137 cm
3.0M	524 Lx	684 Lx	206 cm
4.0M	292 Lx	381 Lx	275 cm
5.0M	186 Lx	242 Lx	344 cm

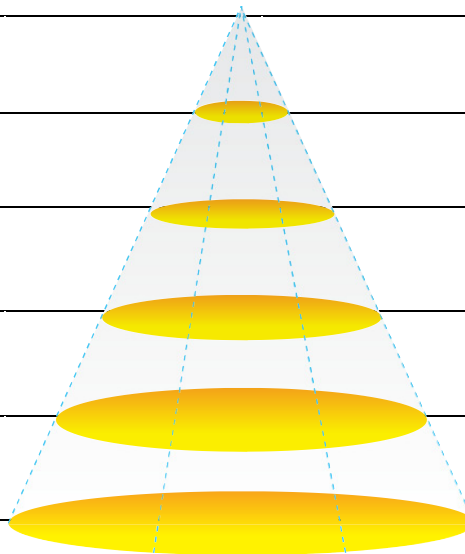

GL-TSL30 –NW-38D / CCT: 4000K

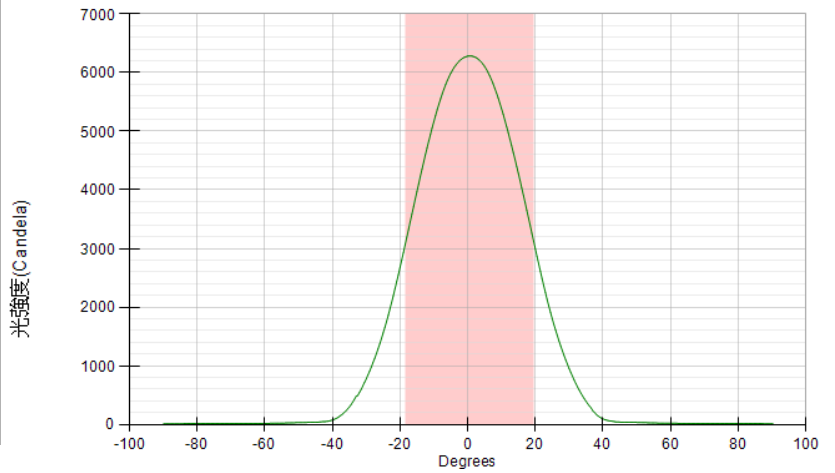
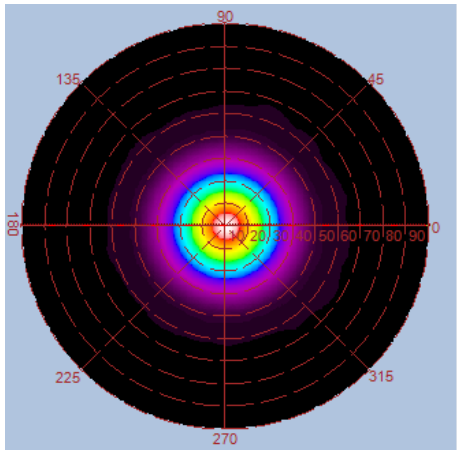
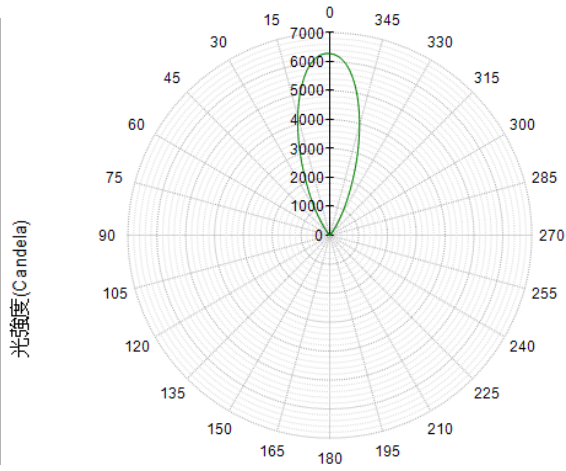
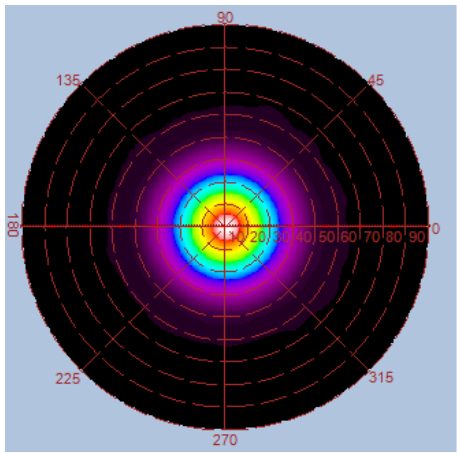

Height	E Avg.	E Max.	Diameter
1.0M	5357 Lx	7201 Lx	68 cm
2.0M	1276 Lx	1684 Lx	137 cm
3.0M	556 Lx	726 Lx	206 cm
4.0M	311 Lx	407 Lx	275 cm
5.0M	197 Lx	256 Lx	344 cm

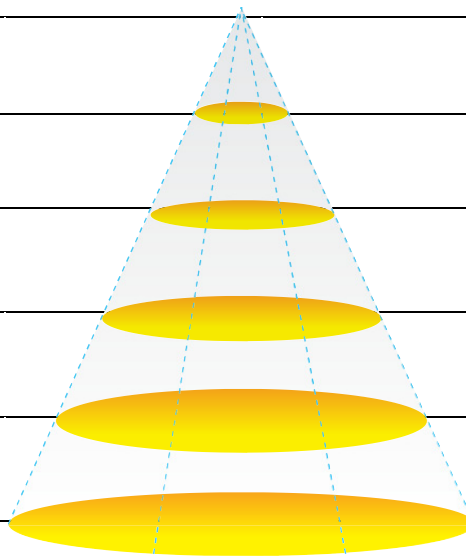

GL-TSL30 –CW-38D / CCT: 5000K

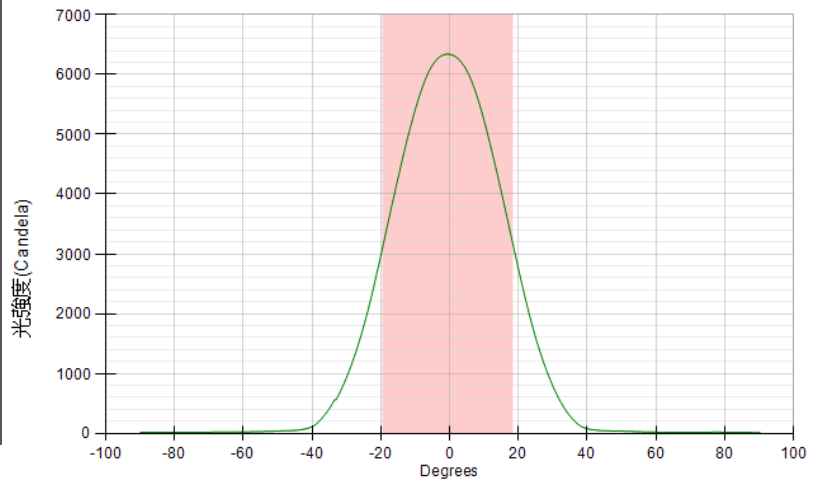
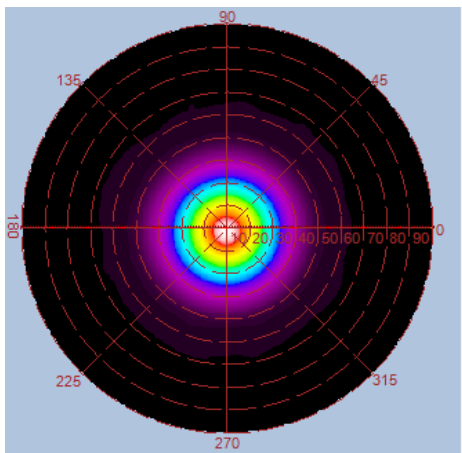
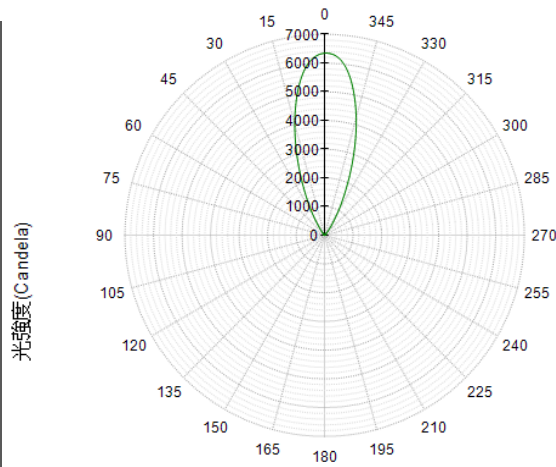
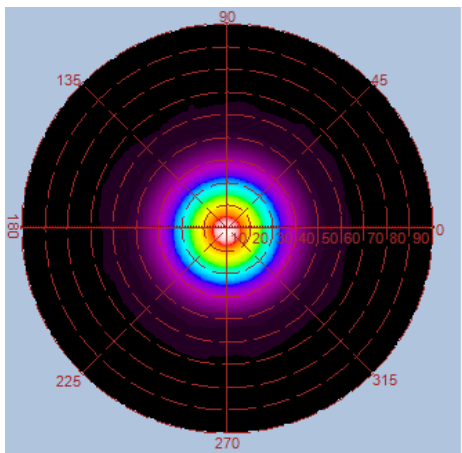

Height	E Avg.	E Max.	Diameter
1.0M	5388 Lx	7203 Lx	68 cm
2.0M	1288 Lx	1695 Lx	137 cm
3.0M	563 Lx	734 Lx	206 cm
4.0M	313 Lx	407 Lx	275 cm
5.0M	200 Lx	259 Lx	344 cm

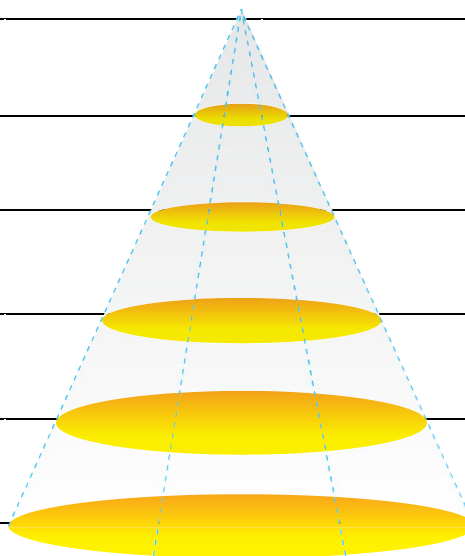

Outline / Dimension

Type B: Ø 132 x 252 mm (Surface mount)

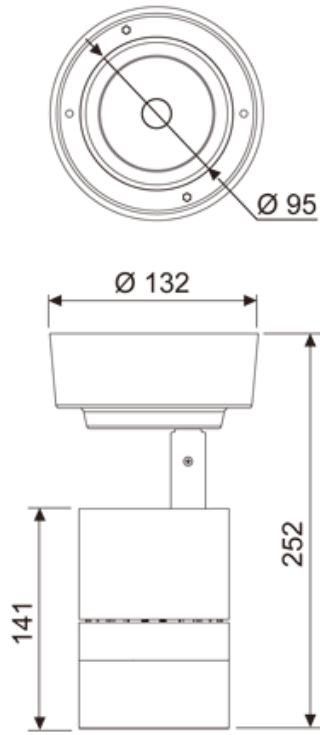

Gallery

