

LED Natural Sunlight (with DC Input Voltage)

GL-LMR50-06-24V-NL

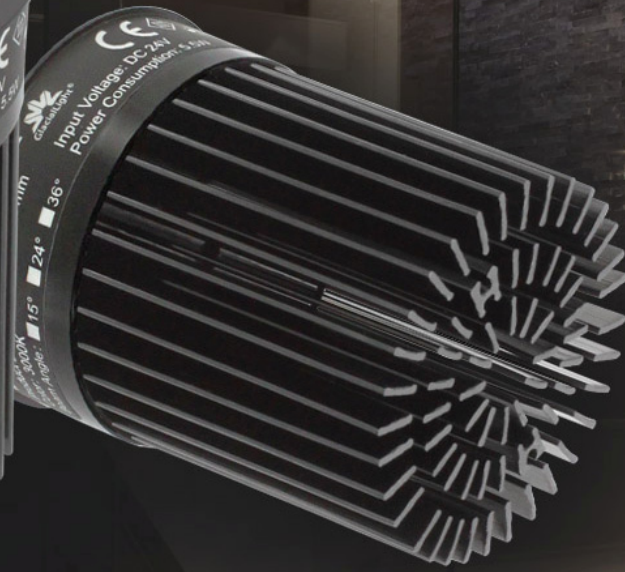

24V
DC
INPUT

Features

- High CRI is 97.
- High CQS is 97.
- TM-30-15 Rf is up to 95.
- TM-30-15 Rg is up to 103.
- DC 24V input voltage and polarity insensitive.
- 15°, 24° and 36° beam angle available.
- Can be dimmable with given the appropriate DC electrical signal (typ. PWM).
- Optional round and square single housing accessories in black and white colors.
- Mistake-proofing design for user friendly.
- Expandable design of installation lighting fixtures.

CE FC IP66



Specifications

Model No.	GL-LMR50-06-24V-NL-WW
Energy Used	5.5 W
Rated Life	30,000 Hours
Input Voltage	DC 24V / +7% , -10%
CCT (color)	3000K
Luminous Flux	360 lm
System Efficacy	65 lm/W
CRI (Typ.)	97
CQS (Typ.)	97
TM-30-15 Rf (Typ.)	95
TM-30-15 Rg (Typ.)	103
Beam Angle	15° / 24° / 36°
Dimension	Ø 50 x 60mm
IP Rating	IP20
Operation Temperature	-20°C ~ +40°C
Net Weight	90 g
Package	25 PCS / Carton

Outline / Dimension

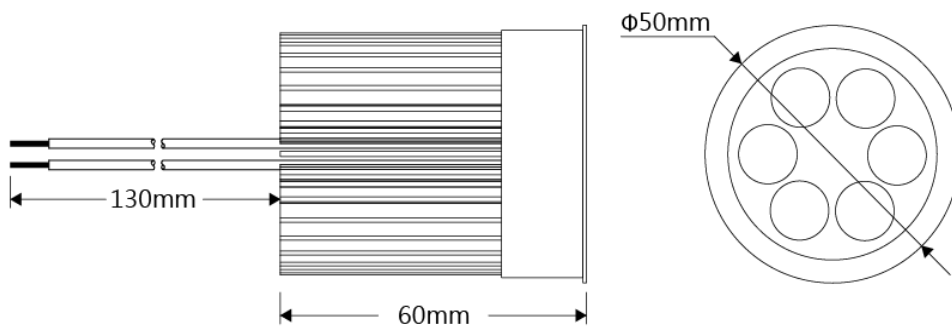

Luminous Intensity Distribution Diagram

GL-LMR50-06-24V-NL-WW-3000K-15D

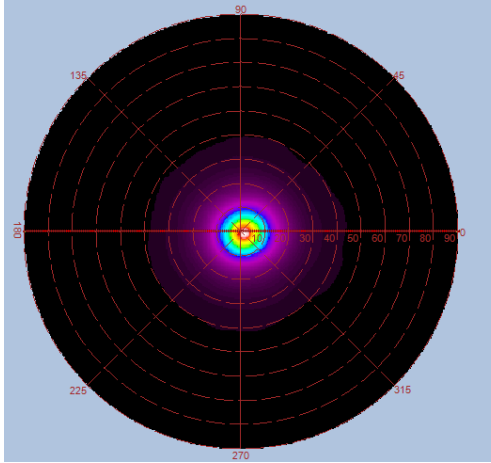

光强度 (Candela)

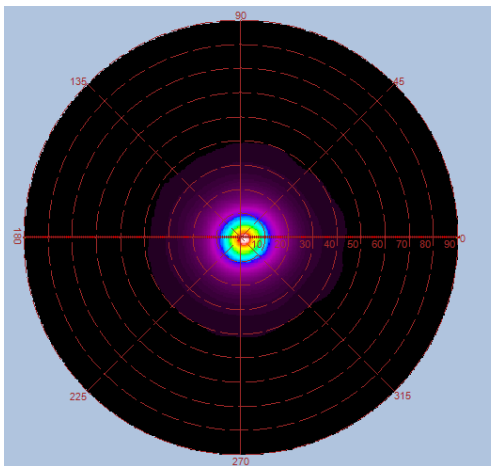
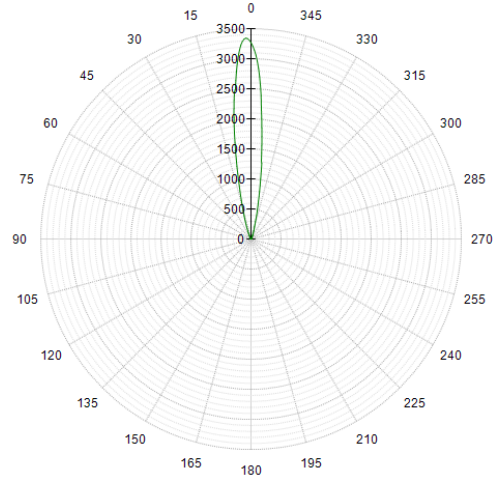

光强度 (Candela)

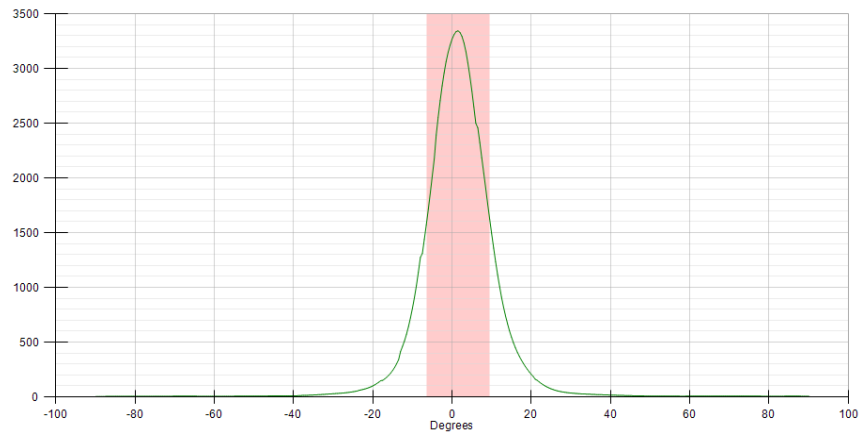

Height	E Avg.	E Max.	Diameter
1.0M	3142 Lx	4100 Lx	26 cm
2.0M	757 Lx	969 Lx	53 cm
3.0M	333 Lx	422 Lx	79 cm
4.0M	186 Lx	235 Lx	105 cm
5.0M	118 Lx	149 Lx	132 cm

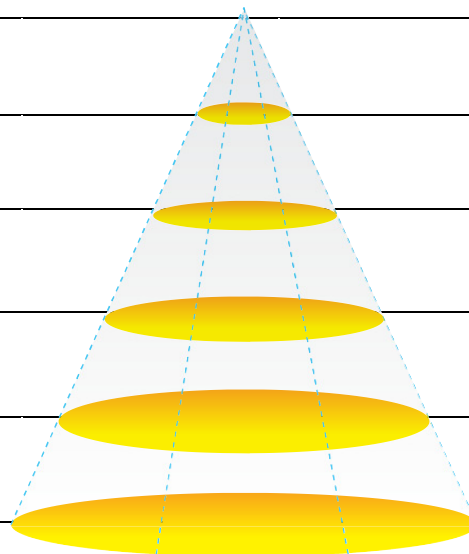

GL-LMR50-06-24V-NL-WW-3000K-24D

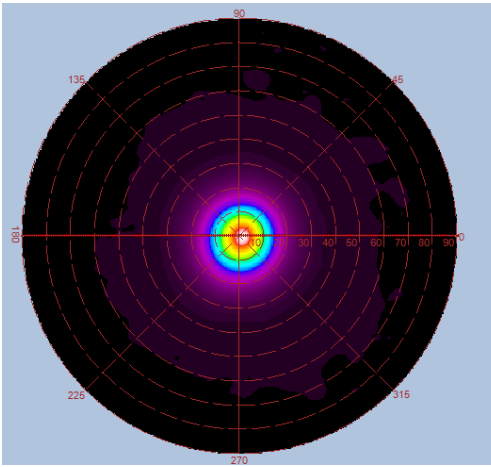

光强度(Candela)

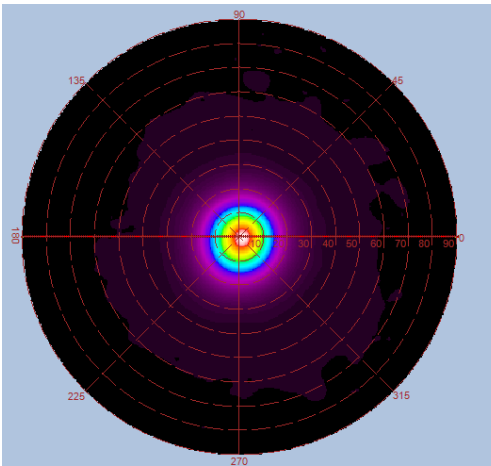
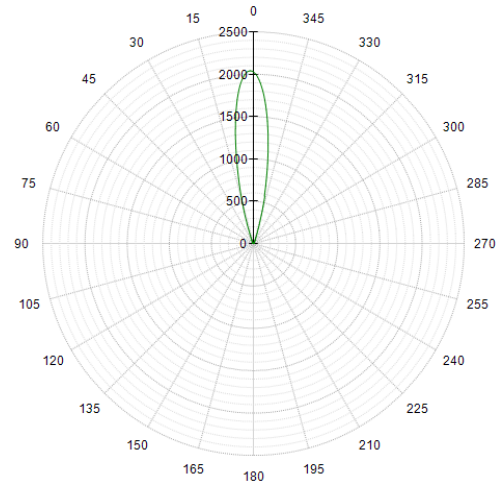

光强度(Candela)

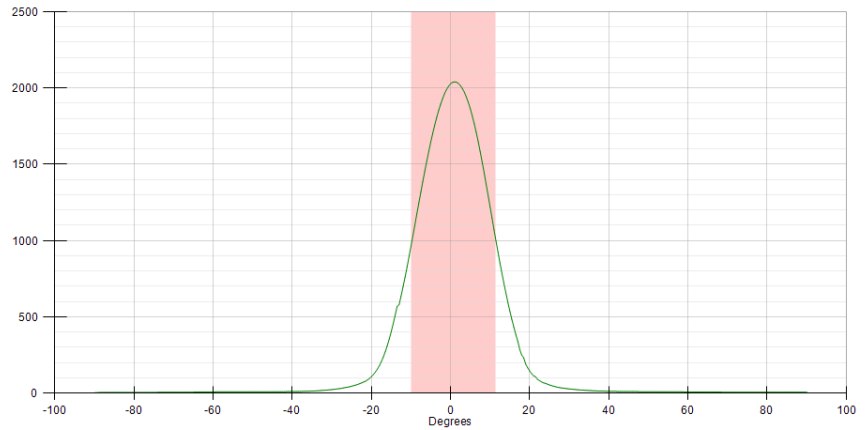

Height	E Avg.	E Max.	Diameter
1.0M	1839 Lx	2581 Lx	43 cm
2.0M	440 Lx	598 Lx	85 cm
3.0M	193 Lx	260 Lx	128 cm
4.0M	107 Lx	144 Lx	170 cm
5.0M	68 Lx	92 Lx	213 cm

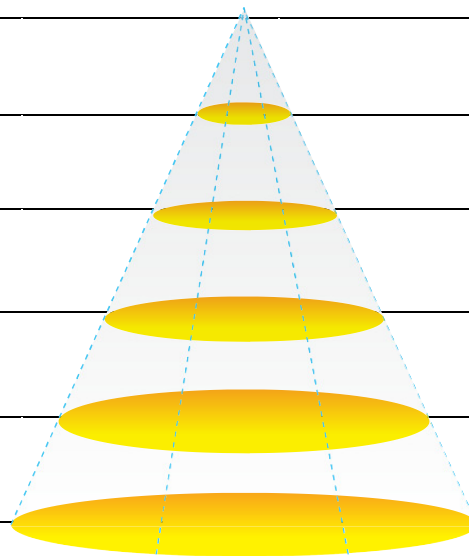

GL-LMR50-06-24V-NL-WW-3000K-36D

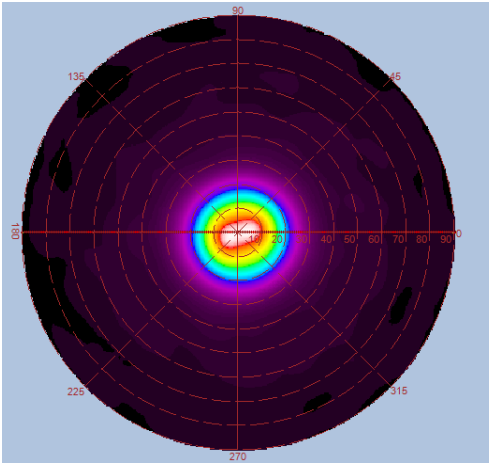

光强度 (Candela)

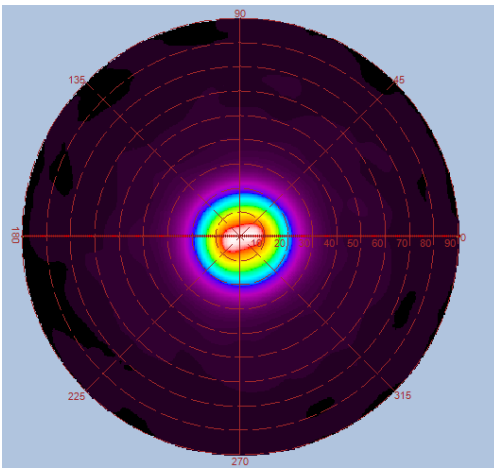
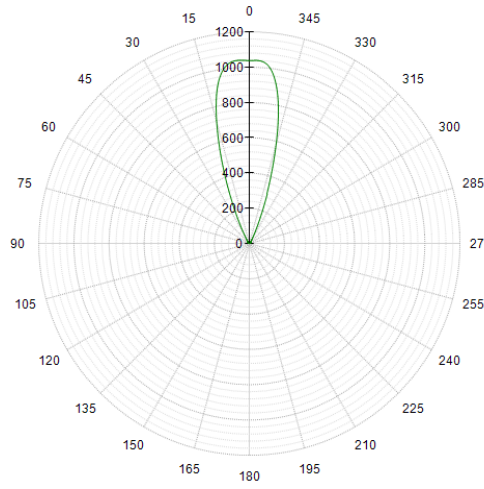

光强度 (Candela)

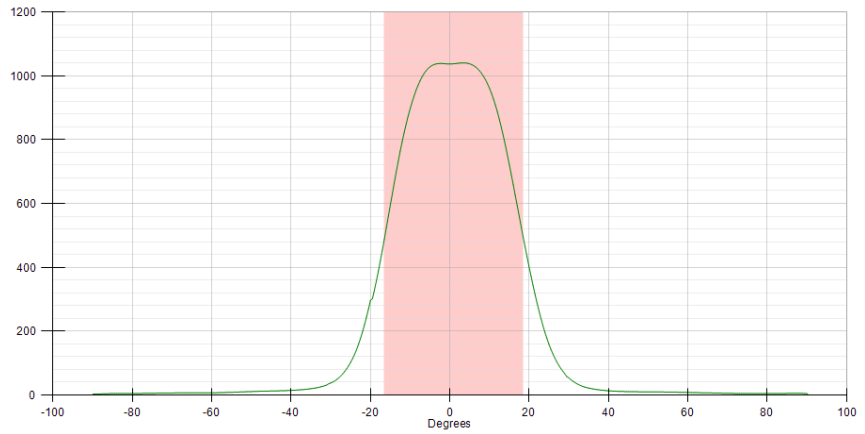

Height	E Avg.	E Max.	Diameter
1.0M	969 Lx	1245 Lx	65 cm
2.0M	233 Lx	292 Lx	130 cm
3.0M	102 Lx	127 Lx	195 cm
4.0M	57 Lx	71 Lx	260 cm
5.0M	36 Lx	45 Lx	325 cm

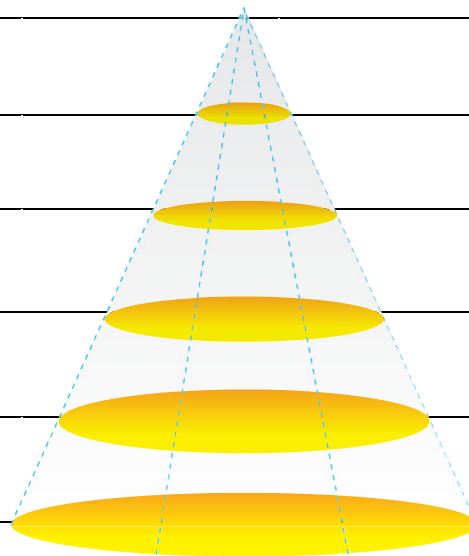

Spectroradiometric Parameters

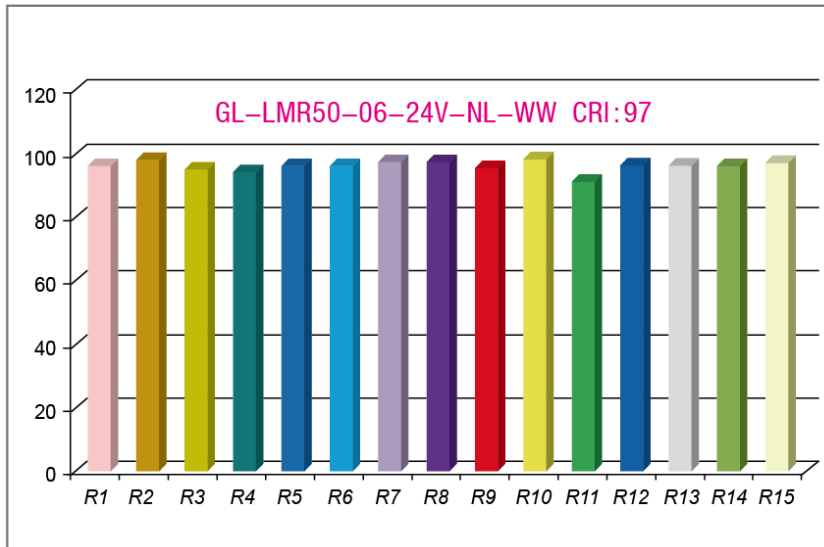
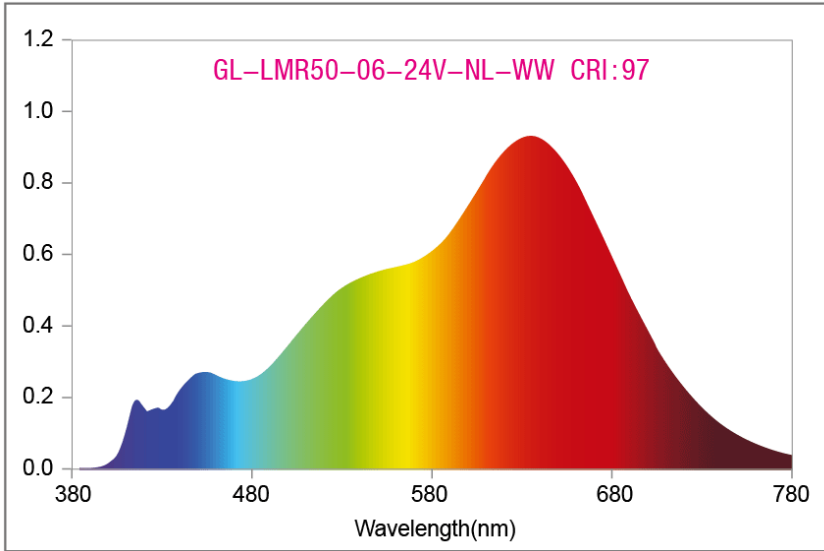

Application

Non-Dimmable

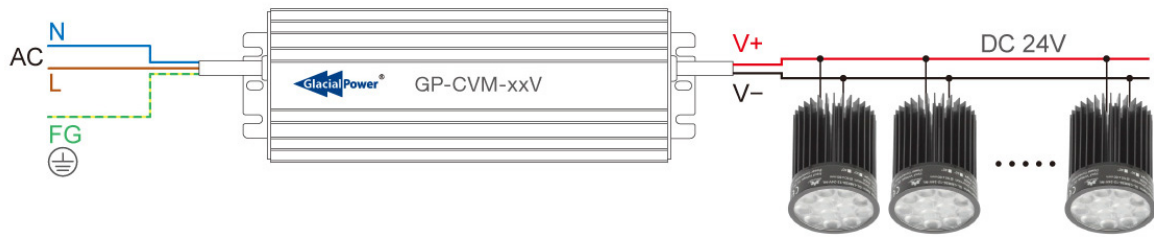

AC-TRIAC Dimmable

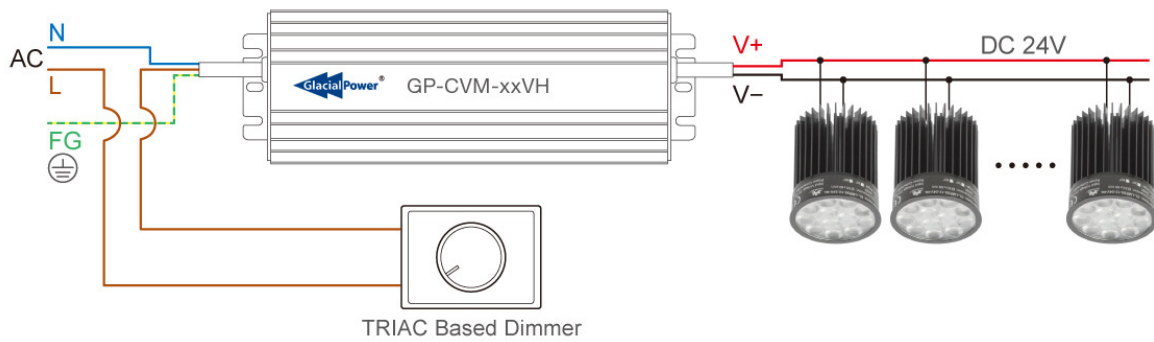

3-in-1 Dimmable

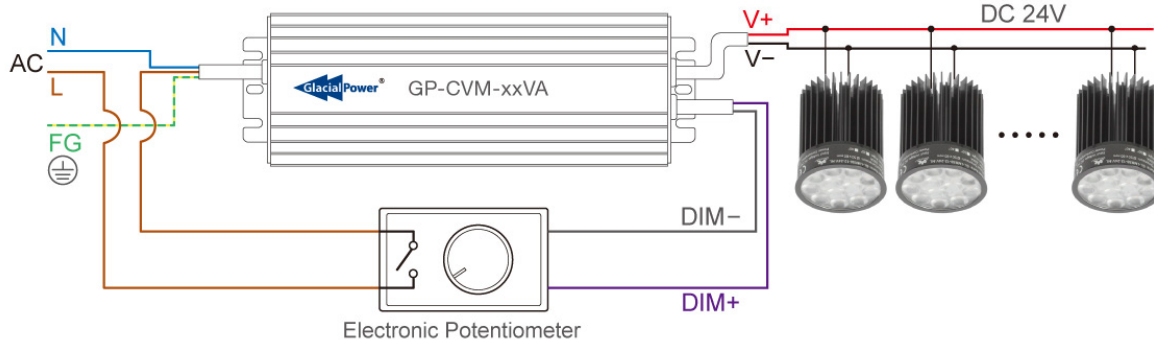

DALI Dimmable

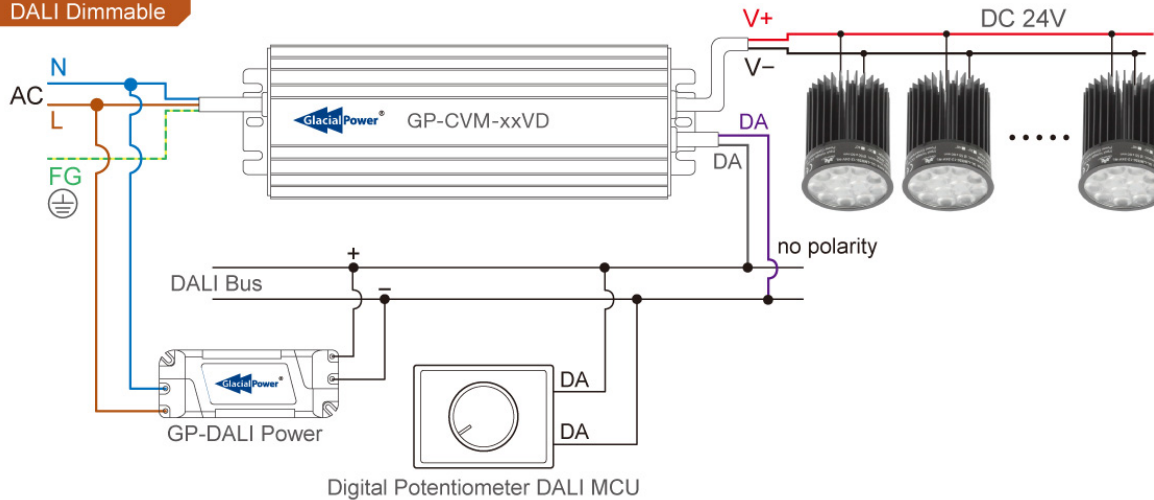

GL-LMR50 application with Solar & Battery

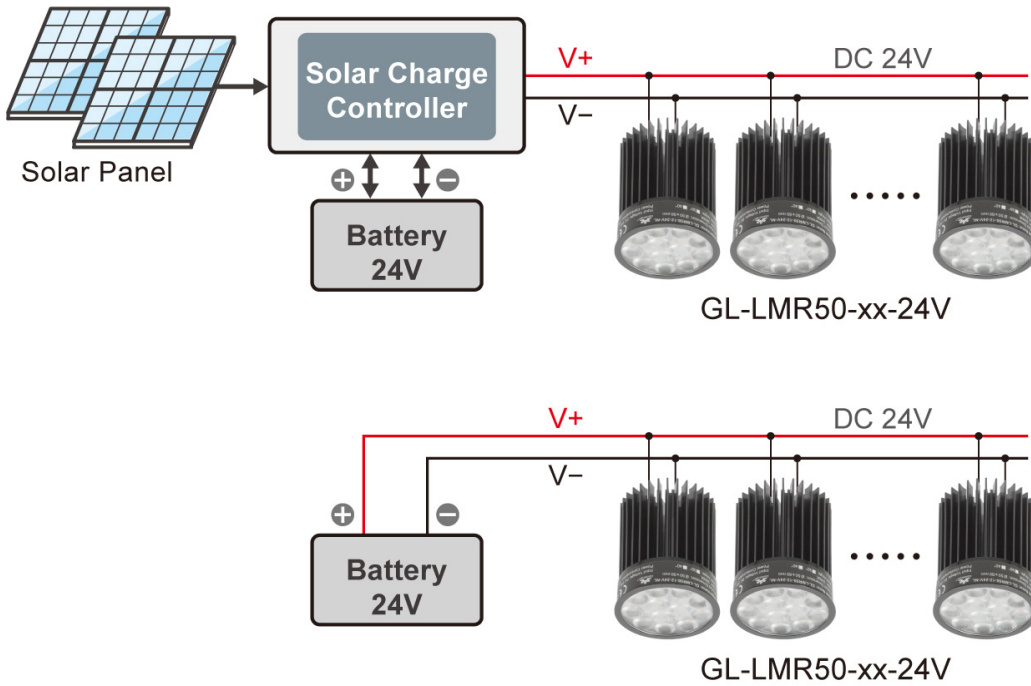

Accessory

Type	Single fixture (for 1 lamp)	Single fixture (for 1 lamp)
Part No.	CE-R5XXI000WS0001	CE-R5XXI000AS0001
External Dimensions	Φ90 mm x 29mm(H)	
Shape	Round	
Fixture Hole	Φ75 mm	
Compatible With	GL-LMR50-XX-24V-NL Series	
Materials/ Color	Aluminum / White	Aluminum / Black
Net Weight	70 g	
Packing	1 PCS / carton	
Photograph		

Accessory

Type	Single fixture (for 1 lamp)	Single fixture (for 1 lamp)
Part No.	CE-R5XXI000WS1001	CE-R5XXI000AS1001
External Dimensions	90 mm x 90mm x 29mm(H)	
Shape	Square	
Fixture Hole	Φ75 mm	
Compatible With	GL-LMR50-XX-24V-NL Series	
Materials/ Color	Aluminum / White	Aluminum / Black
Net Weight	80 g	
Packing	1 PCS / carton	
Photograph		

Type	Double fixture (for 2 lamps)	Triple fixture (for 3 lamps)
Part No.	CE-R5XXI000WS1011	CE-R5XXI000WS1021
External Dimensions	185 mm x 95mm x 29mm(H)	270 mm x 95mm x 29mm(H)
Shape	Rectangle	
Fixture Hole	165 mm x 75mm	250 mm x 75mm
Compatible With	GL-LMR50-XX-24V-NL Series	
Materials/ Color	Aluminum / White	
Net Weight	200 g	300 g
Packing	1 PCS / carton	
Photograph		

