



## Features

- Indoor & outdoor use
- Ideal for transport flood lighting
- Possible to be paired with solar panels
- Automatically detects and adapts to a 12V DC or 24V DC input
- Lightweight build (1.2kg)
- Compact size ( 180 x 140 x 105mm)
- LED chips by Philips Lumileds
- Low power consumption: 27W

GlacialLight®

Lighting You Always

GlacialLight®

Lighting You Always

IP66



## Specifications

| Type                  | GL-FD30-V2-WW               | GL-FD30-V2-CW |
|-----------------------|-----------------------------|---------------|
| Energy Used           | 27 W                        |               |
| Rated Life            | 30,000 Hours                |               |
| Input Voltage         | 11-15V DC / 22-30V DC       |               |
| Input Current (Max.)  | 4A at 11V DC / 2A at 22V DC |               |
| CCT (color)           | 3000K                       | 5700K         |
| Luminous Flux         | 1570 lm                     | 1900 lm       |
| System Efficacy       | 58 lm/W                     | 70 lm/W       |
| CRI                   | 85                          | 70            |
| Beam Angle            | 30° / 60°                   |               |
| Dimension             | 180 x 140 x 105 mm          |               |
| IP Rating             | IP66                        |               |
| Operation Temperature | -20°C ~ +40°C               |               |
| Net Weight            | 1.2kg                       |               |
| Package               | 6 Box / Carton              |               |

## Outline / Dimension

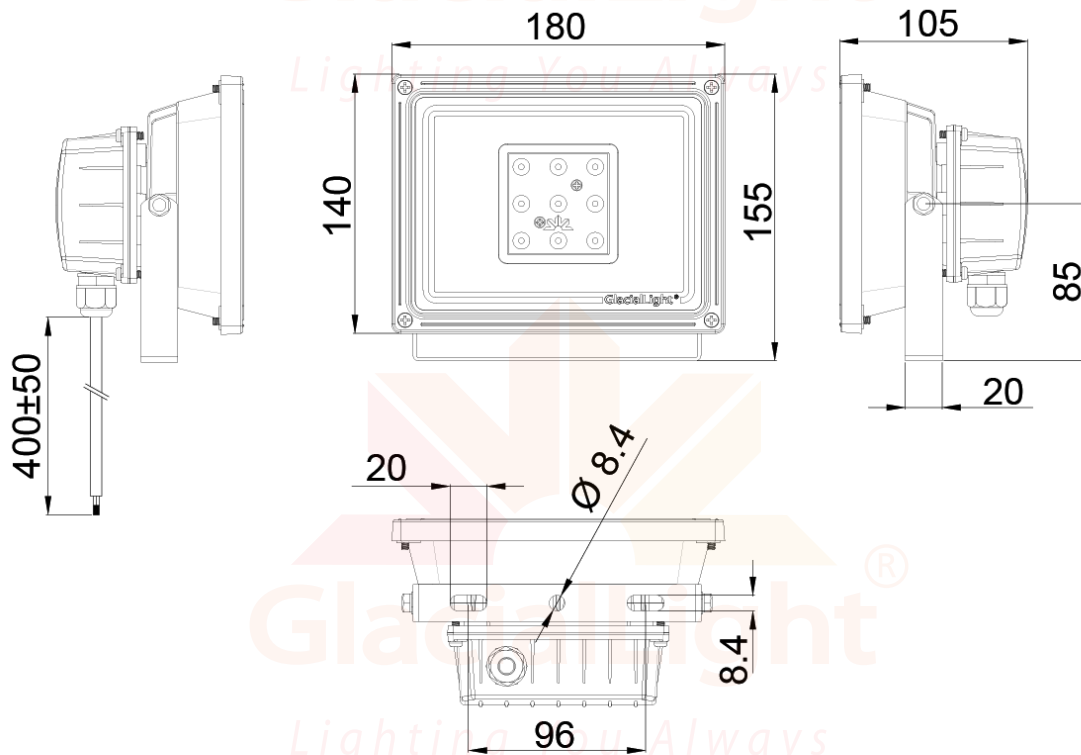

※ UNIT:mm

※ Philips Lumileds LED

## Luminous Intensity Distribution Diagram

GL-FD30-V2-WW-30D/ CCT: 3000K

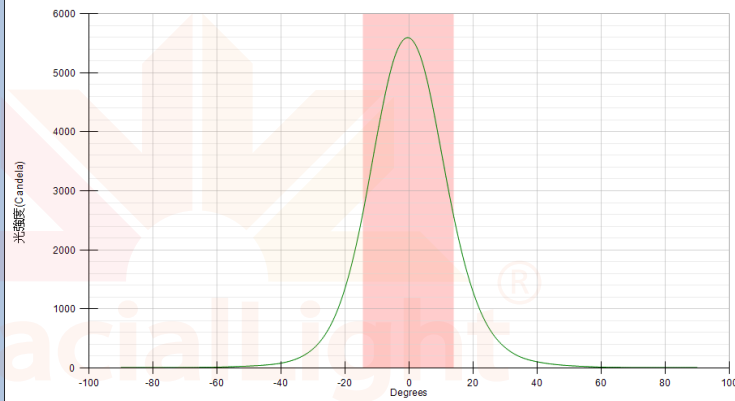
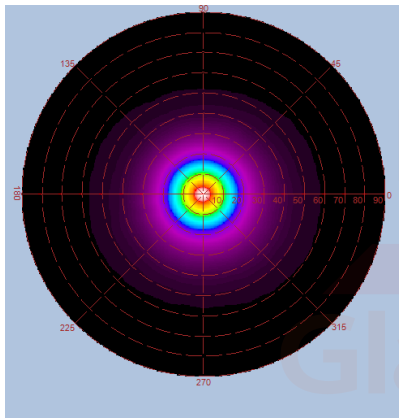
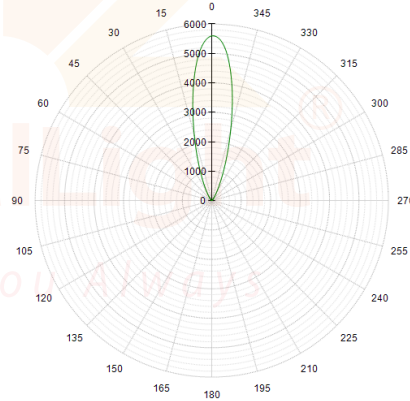
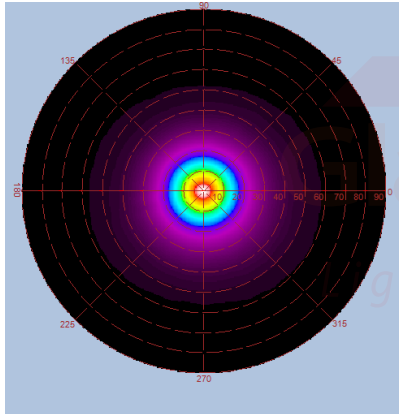

Lighting You Always

| Height | E Max.   | Diameter |
|--------|----------|----------|
| 1.0M   | 4255 Lx  | 0.508m   |
| 2.0M   | 1073 Lx  | 1.016m   |
| 3.0M   | 478 Lx   | 1.524m   |
| 4.0M   | 269.2 Lx | 2.032m   |
| 5.0M   | 172.1 Lx | 2.540m   |

Lighting You Always

## Luminous Intensity Distribution Diagram

GL-FD30-V2-WW-60D/ CCT: 3000K

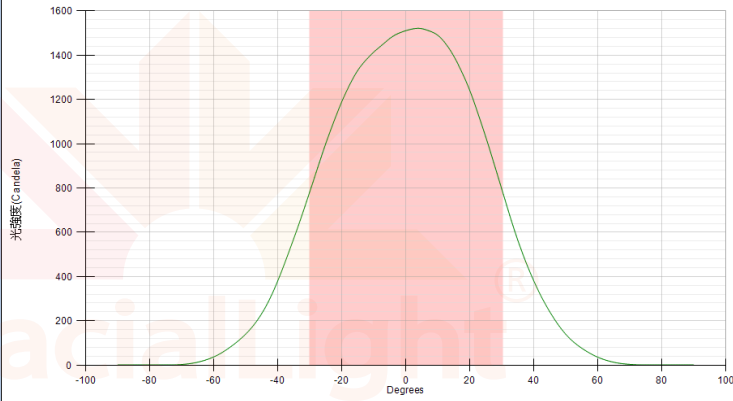
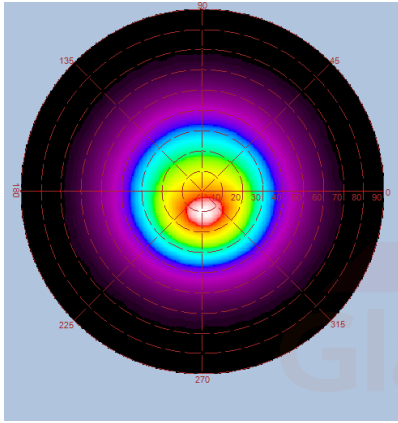
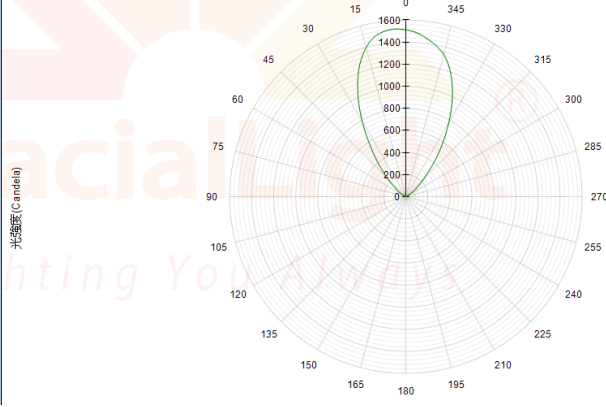
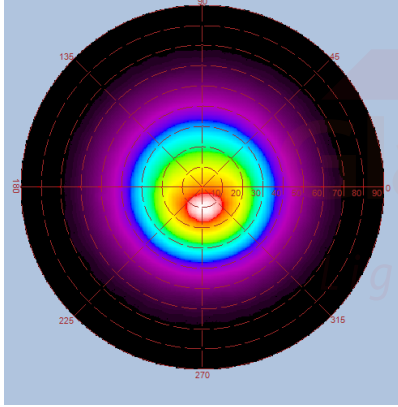

Lighting You Always

| Height | E Max.   | Diameter |
|--------|----------|----------|
| 1.0M   | 1083 Lx  | 1.466m   |
| 2.0M   | 273.4 Lx | 2.333m   |
| 3.0M   | 121.9 Lx | 3.499m   |
| 4.0M   | 68.7 Lx  | 4.665m   |
| 5.0M   | 43.9 Lx  | 5.832m   |

Lighting You Always

## Luminous Intensity Distribution Diagram

GL-FD30-V2-CW-30D/ CCT: 5700K

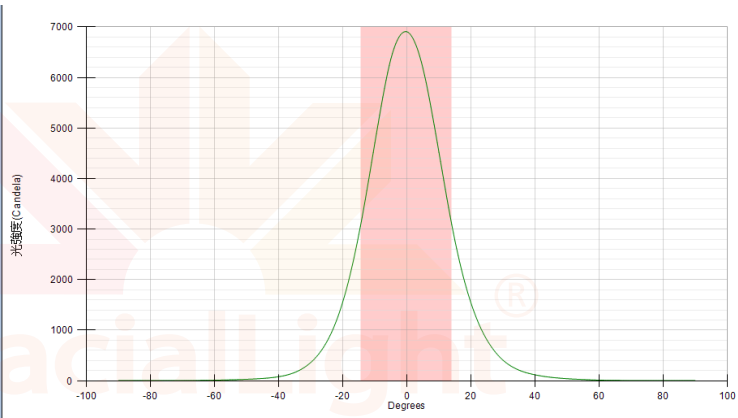
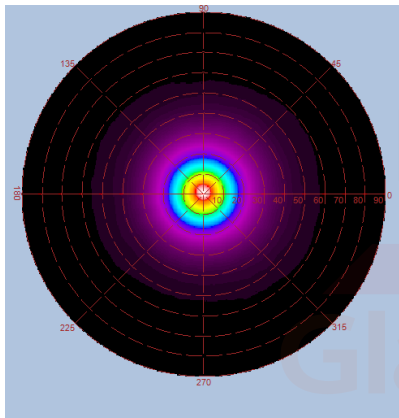
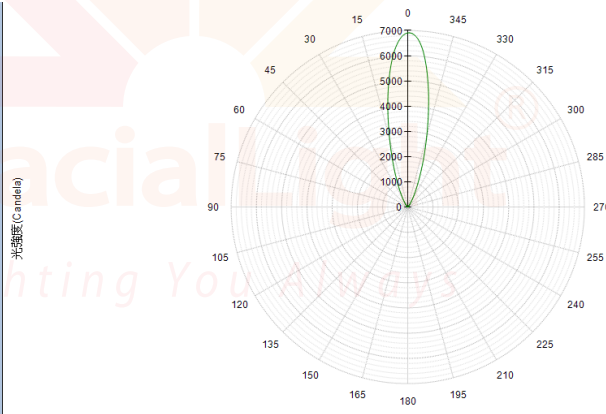
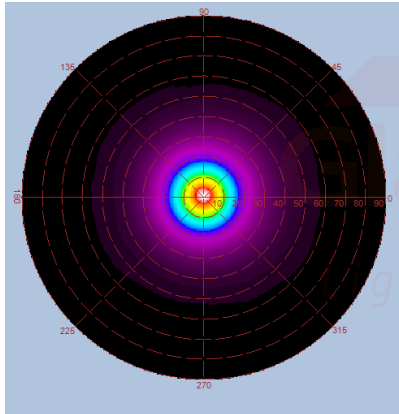

Lighting You Always

| Height | E Max.  | Diameter |
|--------|---------|----------|
| 1.0M   | 7417 Lx | 0.508m   |
| 2.0M   | 1820 Lx | 1.016m   |
| 3.0M   | 793 Lx  | 1.524m   |
| 4.0M   | 443 Lx  | 2.032m   |
| 5.0M   | 281 Lx  | 2.540m   |

Lighting You Always

## Luminous Intensity Distribution Diagram

GL-FD30-V2-CW-60D/ CCT: 5700K

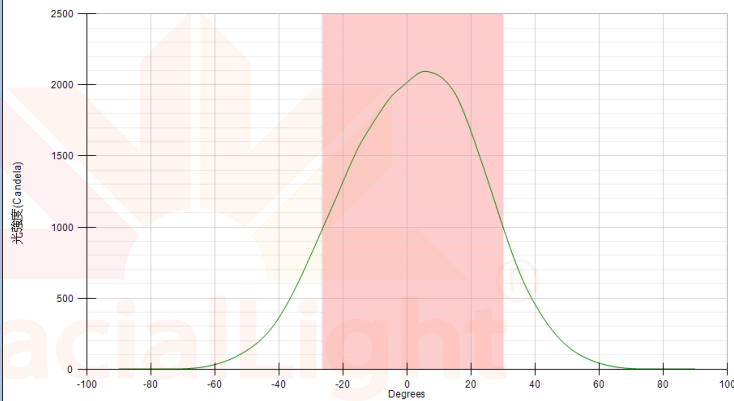
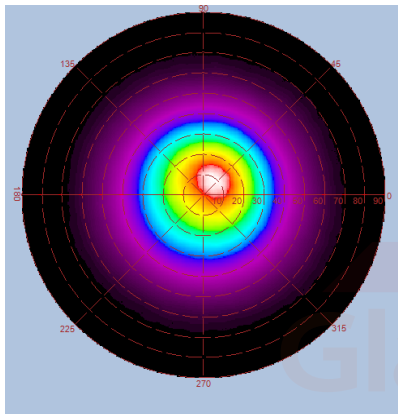
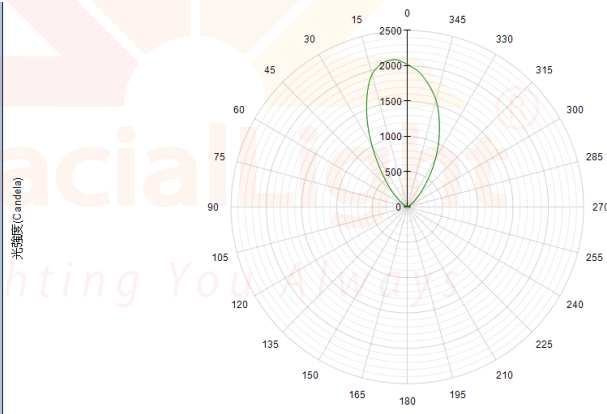
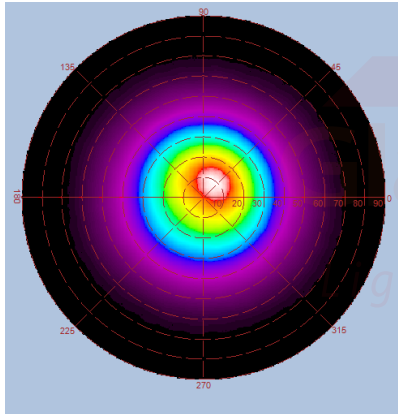

Lighting You Always

| Height | E Max.   | Diameter |
|--------|----------|----------|
| 1.0M   | 1559 Lx  | 1.075m   |
| 2.0M   | 379 Lx   | 2.149m   |
| 3.0M   | 167.3 Lx | 3.224m   |
| 4.0M   | 93.6 Lx  | 4.298m   |
| 5.0M   | 59.8 Lx  | 5.373m   |

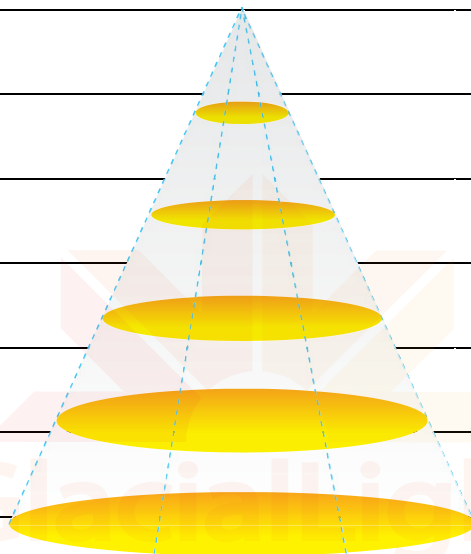

Lighting You Always