



*AC-TRIAC Dimmable  
LED Natural Sunlight*

**GL-AR111-V2ADL-12-NL**  
**GL-AR111-V2ADH-12-NL**

### Features

- High CRI is 97.
- High CQS is 98.
- TM-30-15 Rf is up to 97.
- TM-30-15 Rg is up to 102.
- AC-TRIAC dimming functions optional.
- Optional square gimbals housing kit and round single housing accessories available.



## Specifications

Model No.	GL- AR111-V2ADL-12-NL –WW GL- AR111-V2ADH-12-NL -WW
Energy Used	12W
Rated Life	30,000 Hours
Input Voltage	100-120V AC (AR111-V2ADL) 200-240V AC (AR111-V2ADH)
Power Factor (PF)	0.92 at 120V AC, 0.8 at 240V AC
CCT (color)	2700K
Luminous Flux	860 lm
System Efficacy	72 lm/W
CRI (Typ.)	97
CQS (Typ.)	98
TM-30-15 Rf (Typ.)	97
TM-30-15 Rg (Typ.)	102
Beam Angle	26°
Base	G53
Dimension	Ø 111 x 52.7mm
IP Rating	IP20
Operation Temperature	-20°C ~ +40°C
Bundled Driver	GP-TS10P-42L (for AC-TRIAC 100-120V AC) GP-TS10P-42H (for AC-TRIAC 200-240V AC) (Driver Output : Constant Current 270mA, 24-42Vdc)
Net Weight	200g (with driver)
Package	36 Boxes / Carton

## Spectrum

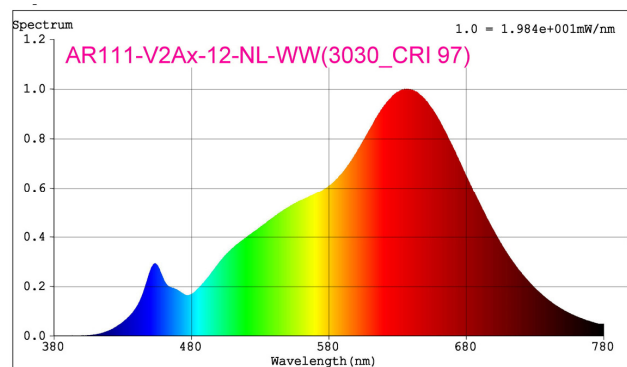
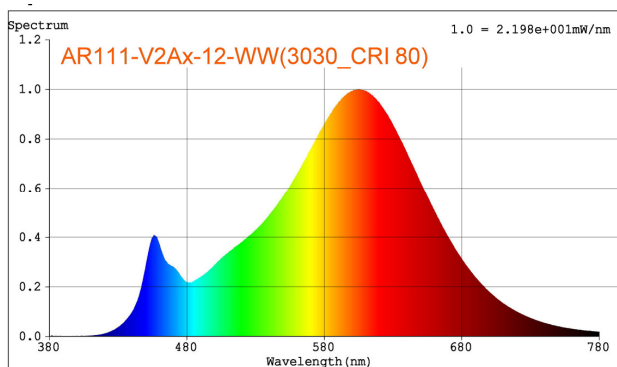

## Luminous Intensity Distribution Diagram

GL-AR111-V2ADL-12-NL-WW-26D / CCT : 2700K

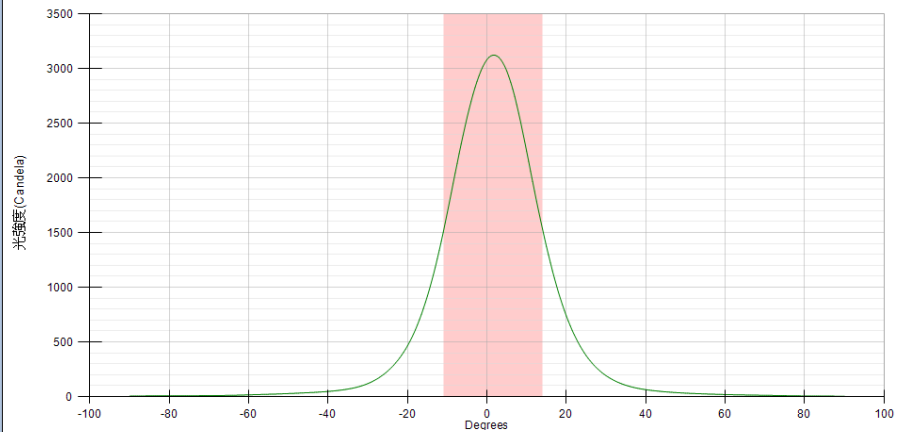
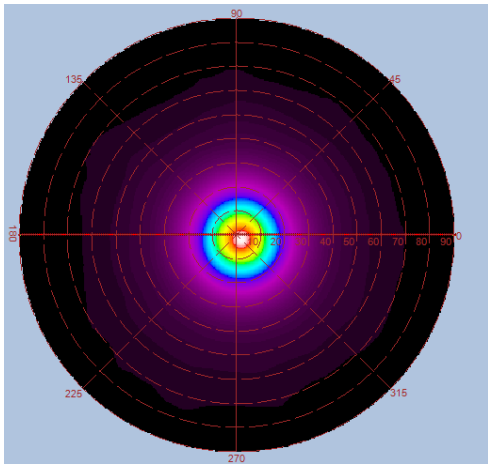
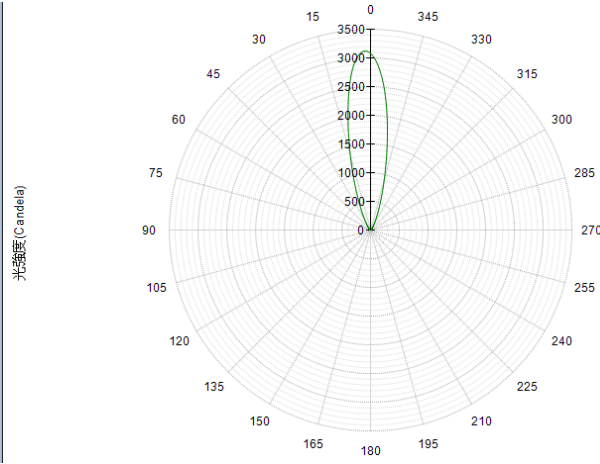
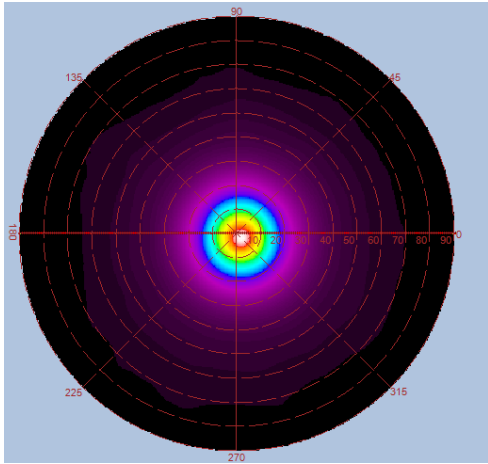

Height	E Avg.	E Max.	Diameter
1.0M	2831 Lx	3817 Lx	46 cm
2.0M	676 Lx	897 Lx	92 cm
3.0M	297 Lx	390 Lx	139 cm
4.0M	166 Lx	217 Lx	185 cm
5.0M	106 Lx	139 Lx	231 cm

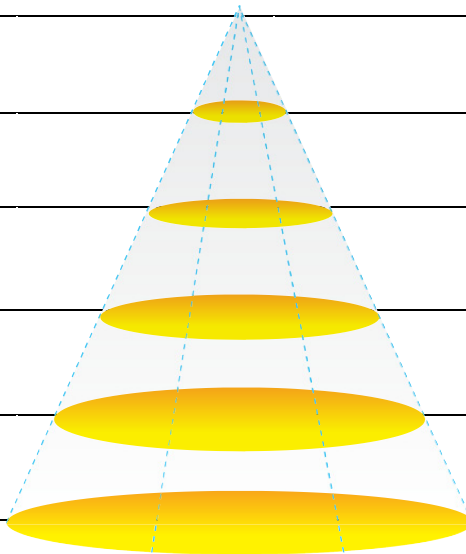

## Luminous Intensity Distribution Diagram

GL-AR111-V2ADH-12-NL-WW-26D / CCT : 2700K

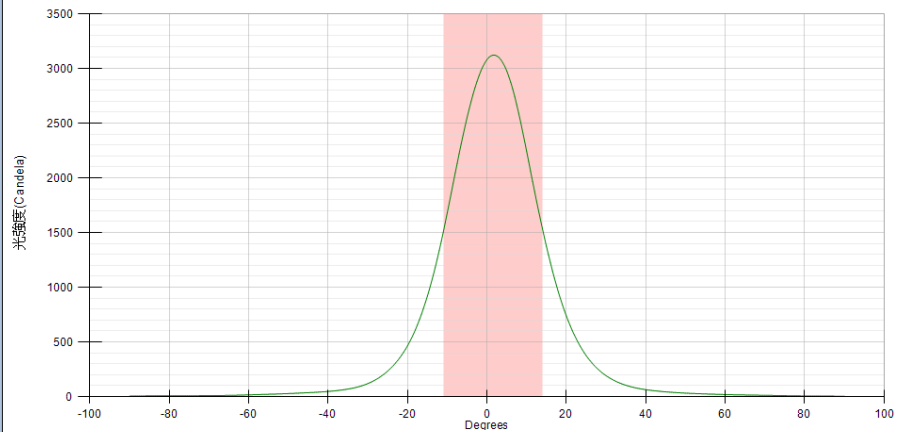
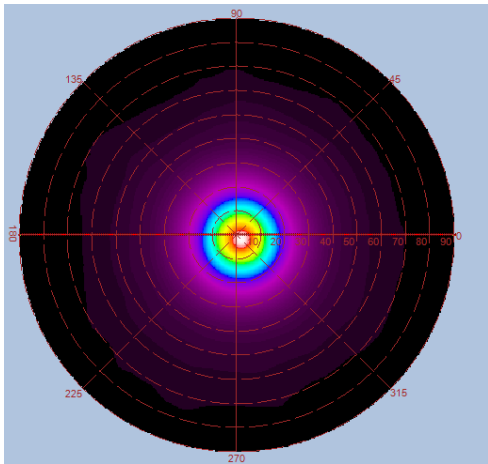
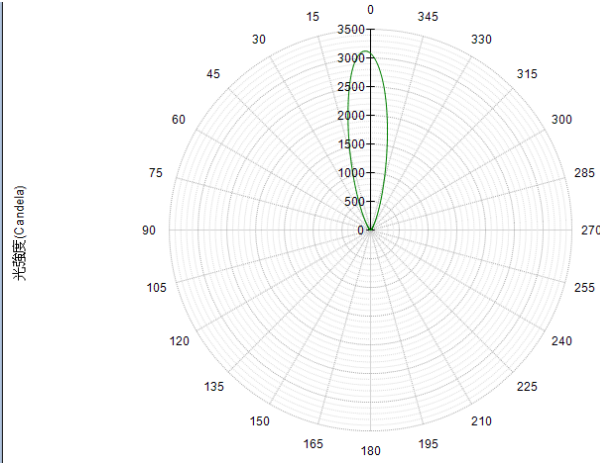
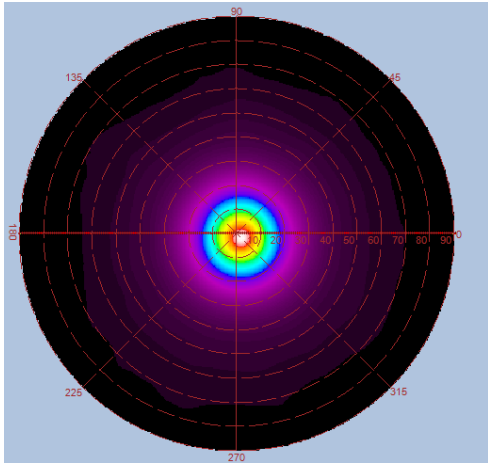

Height	E Avg.	E Max.	Diameter
1.0M	2831 Lx	3817 Lx	46 cm
2.0M	676 Lx	897 Lx	92 cm
3.0M	297 Lx	390 Lx	139 cm
4.0M	166 Lx	217 Lx	185 cm
5.0M	106 Lx	139 Lx	231 cm

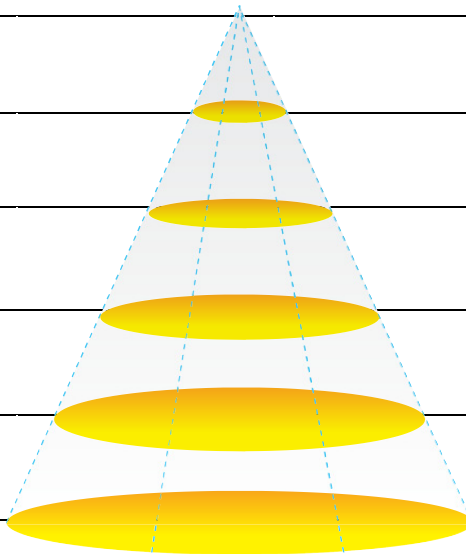



## Outline / Dimension

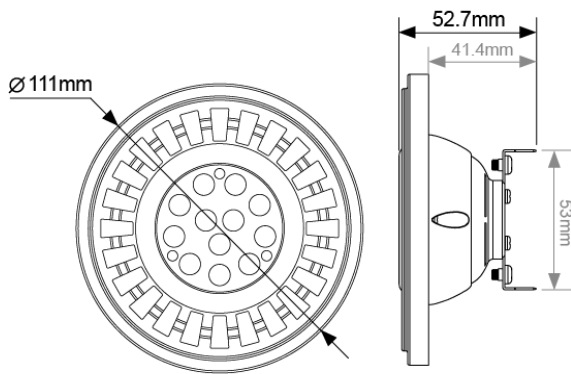

Bundled Driver :  GlacialPower® GlacialPower LED Driver



AC-TRIAC Dimmable : GP-TS10P-42L  
GP-TS10P-42H

## Application

