



Features

- Housing color options: white, black and red
- High system efficacy up to 107 lm/W
- Attachment options: cable or metal pendant rod
- IP65 certified lighting fixture
- Optional dimming available
- Frosted cover softens light and comes with lampshade or without for lower installations
- Glass lens cover available for direct lighting, suitable for higher installations



Specifications

GL-BL30DA (DC dimmable: 1-10V/PWM/Resistor) Glass Lens with lampshade

Type	GL-BL30DA-WW	GL-BL30DA-NW	GL-BL30DA-CW
Energy Used	30W		
Rated Life	30,000 Hours		
Input Voltage	100-240V AC (Driver with CUL Certificate Support 277V AC for North America only)		
Power Factor (PF)	0.98 at 120V AC, 0.94 at 240V AC without dimmer		
CCT (color)	3000K	4000K	5000K
Luminous Flux	3050 lm	3150 lm	3200 lm
System Efficacy	102 lm/W	105 lm/W	107 lm/W
CRI (Minimum)	80	80	80
Beam Angle	70° with lampshade		
Dimension	Φ 305 x 300mm		
IP Rating	IP65		
Operation Temperature	-20°C ~ +40°C		
Net Weight	2.2kg (with driver & lampshade)		
Package	4 Boxes / Carton		

GL-BL30DA (DC dimmable: 1-10V/PWM/Resistor) Frosted Cover with lampshade (default shipment)

Type	GL-BL30DA-WW	GL-BL30DA-NW	GL-BL30DA-CW
Energy Used	30W		
Rated Life	30,000 Hours		
Input Voltage	100-240V AC (Driver with CUL Certificate Support 277V AC for North America only)		
Power Factor (PF)	0.98 at 120V AC, 0.94 at 240V AC without dimmer		
CCT (color)	3000K	4000K	5000K
Luminous Flux	2400 lm	2450 lm	2550 lm
System Efficacy	80 lm/W	82 lm/W	85 lm/W
CRI (Minimum)	80	80	80
Beam Angle	90° with lampshade		
Dimension	Φ 305 x 300mm		
IP Rating	IP65		
Operation Temperature	-20°C ~ +40°C		
Net Weight	2.1kg (with driver & lampshade)		
Package	4 Boxes / Carton		

GL-BL30DA (DC dimmable: 1-10V/PWM/Resistor) Frosted Cover without lampshade

Type	GL-BL30DA-WW	GL-BL30DA-NW	GL-BL30DA-CW
Energy Used	30W		
Rated Life	30,000 Hours		
Input Voltage	100-240V AC (Driver with CUL Certificate Support 277V AC for North America only)		
Power Factor (PF)	0.98 at 120V AC, 0.94 at 240V AC without dimmer		
CCT (color)	3000K	4000K	5000K
Luminous Flux	2750 lm	2800 lm	2900 lm
System Efficacy	92 lm/W	93 lm/W	97 lm/W
CRI (Minimum)	80	80	80
Beam Angle	110° without lampshade		
Dimension	Φ 200 x 170mm		
IP Rating	IP65		
Operation Temperature	-20°C ~ +40°C		
Net Weight	1.5kg (with driver & lampshade)		
Package	4 Boxes / Carton		

Outline / Dimension

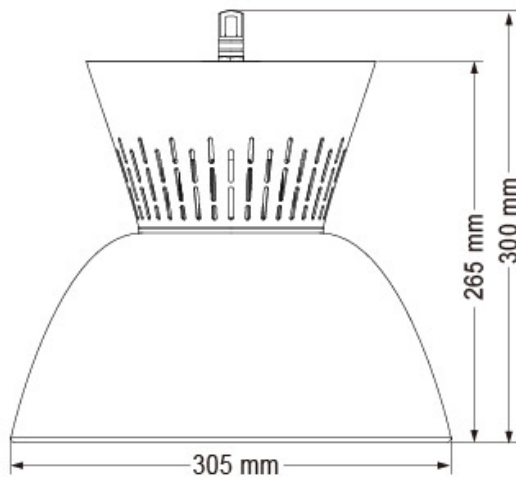

Frosted Cover without lampshade

Glass Lens-with lampshade



Frosted Cover-with lampshade



Frosted Cover-without lampshade



(default shipment)

Luminous Intensity Distribution Diagram

GL-BL30-WW / CCT : 3000K (Glass Lens-with lampshade)

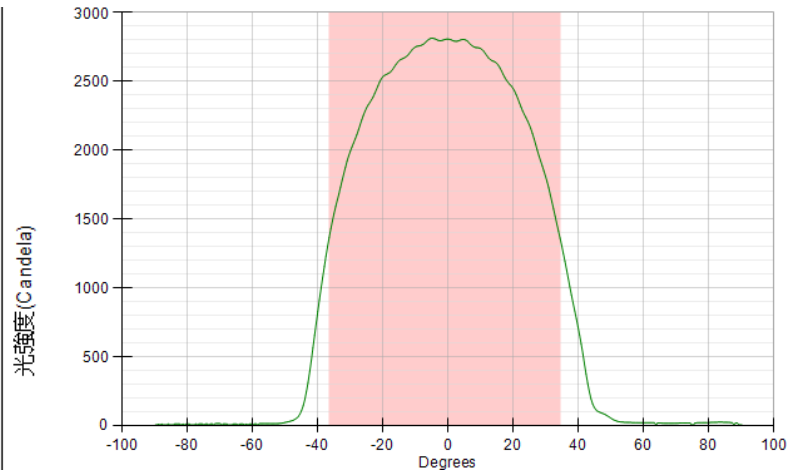
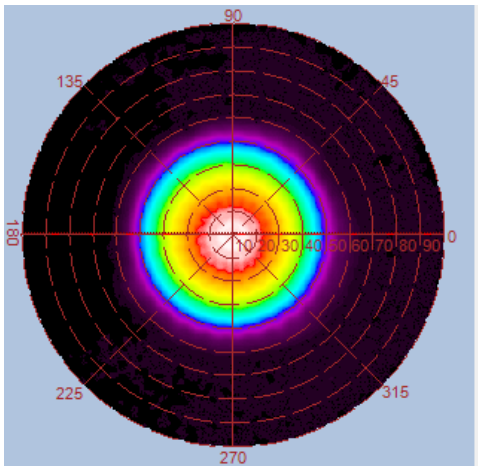
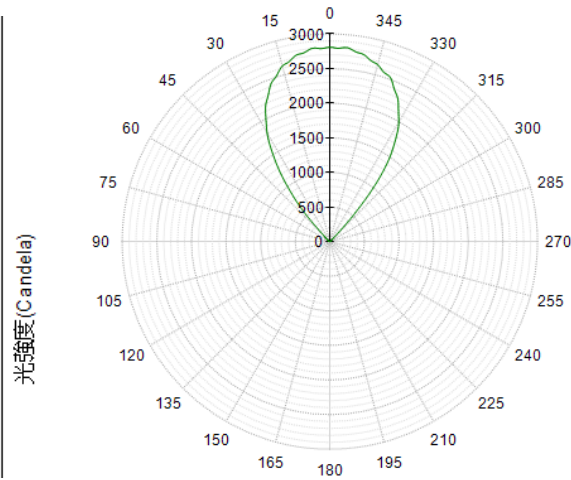
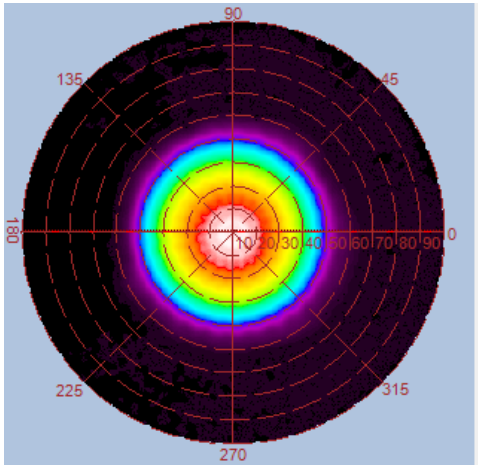

Height	E Avg.	E Max.	Diameter
1.0M	2109 Lx	3171 Lx	142 cm
2.0M	507 Lx	742 Lx	285 cm
3.0M	222 Lx	321 Lx	427 cm
4.0M	124 Lx	178 Lx	570 cm
5.0M	79 Lx	113 Lx	713 cm

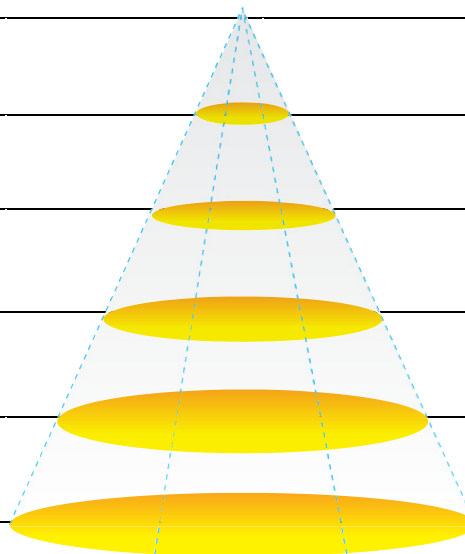

GL-BL30-NW / CCT : 4000K (Glass Lens-with lampshade)

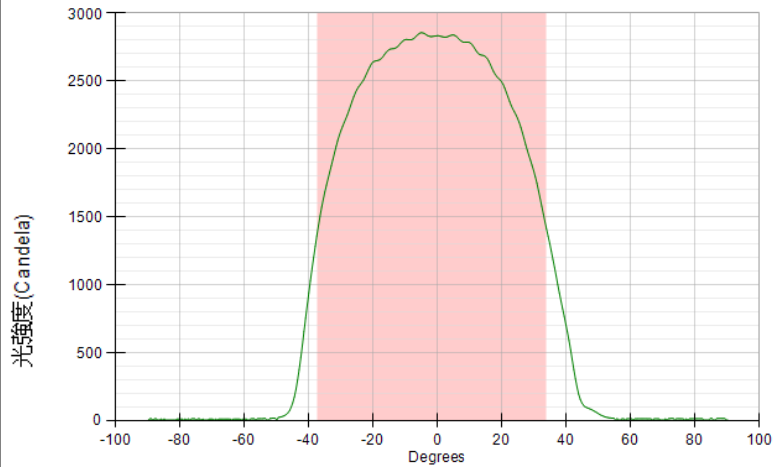
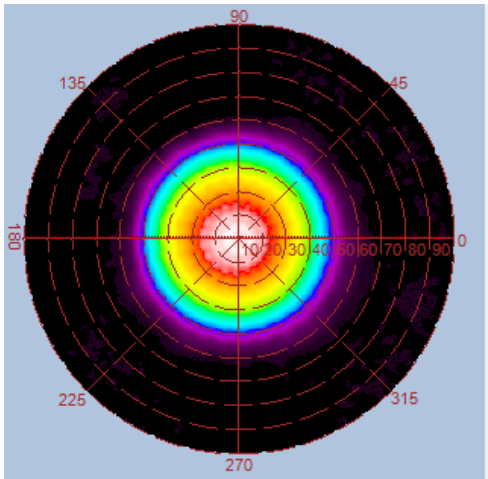
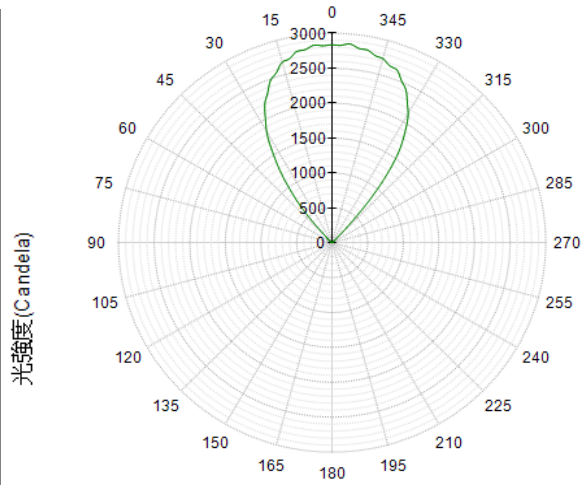
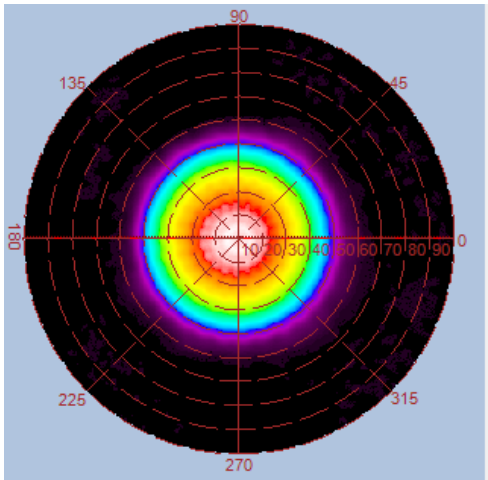

Height	E Avg.	E Max.	Diameter
1.0M	2127 Lx	3176 Lx	143 cm
2.0M	513 Lx	752 Lx	287 cm
3.0M	225 Lx	324 Lx	431 cm
4.0M	125 Lx	180 Lx	575 cm
5.0M	80 Lx	115 Lx	719 cm

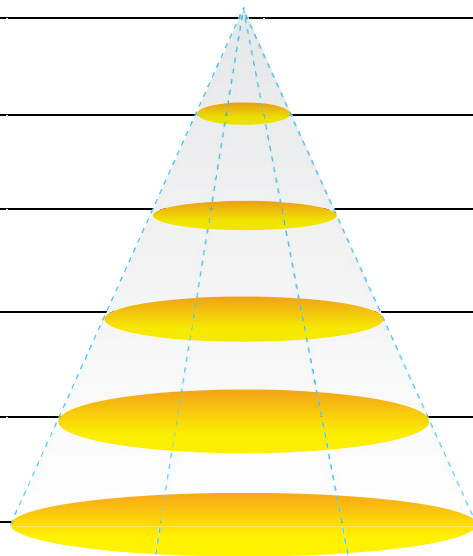

GL-BL30-CW / CCT : 5000K (Glass Lens-with lampshade)

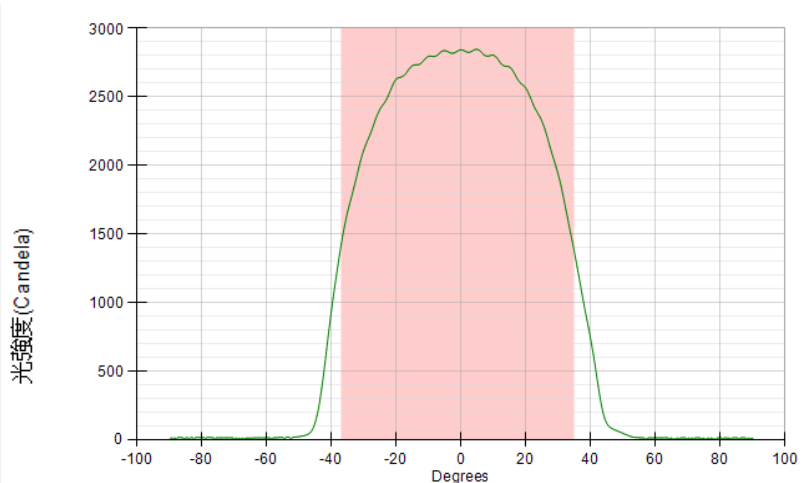
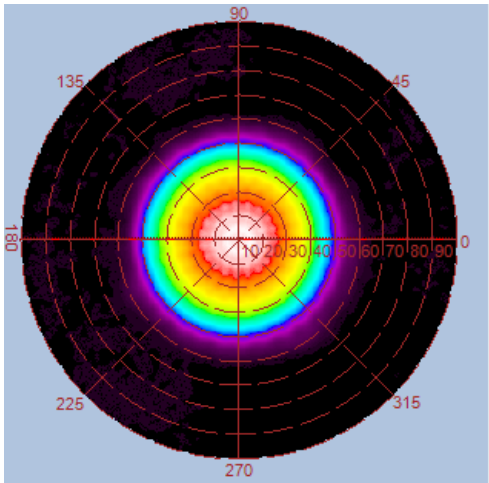
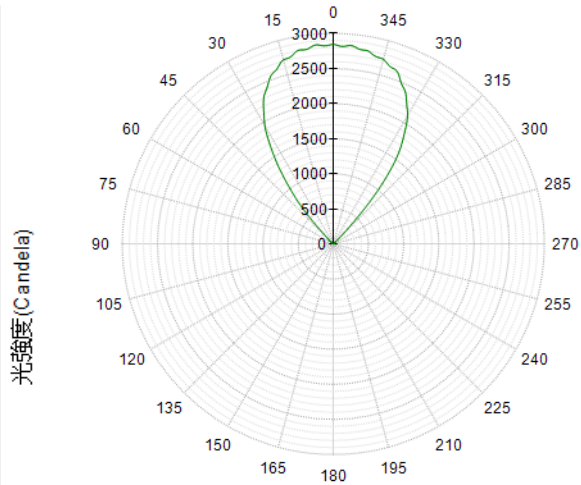
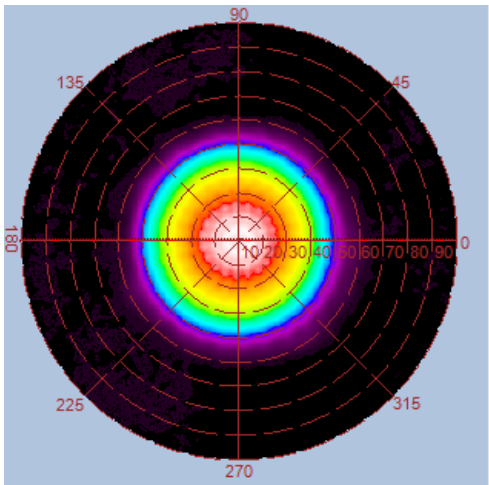

Height	E Avg.	E Max.	Diameter
1.0M	2151 Lx	3201 Lx	145 cm
2.0M	518 Lx	747 Lx	290 cm
3.0M	227 Lx	328 Lx	435 cm
4.0M	126 Lx	180 Lx	581 cm
5.0M	81 Lx	115 Lx	726 cm

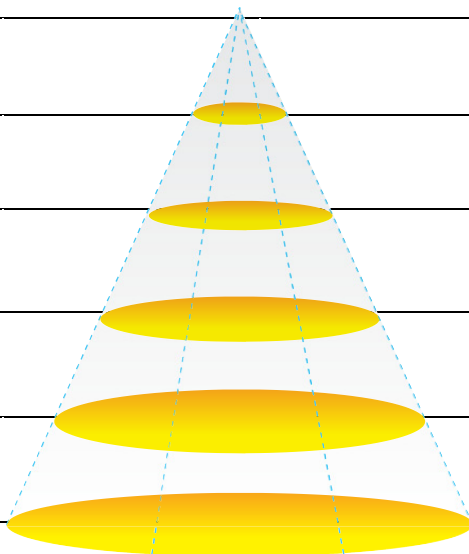

Luminous Intensity Distribution Diagram

GL-BL30-WW / CCT : 3000K (Frosted Cover-with lampshade)

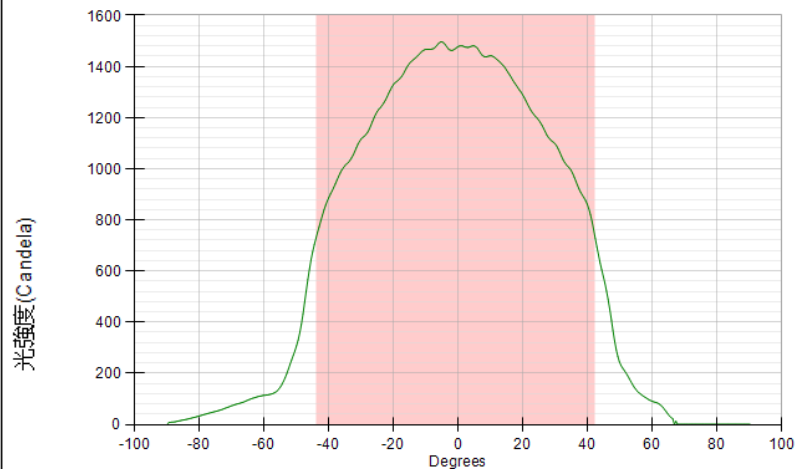
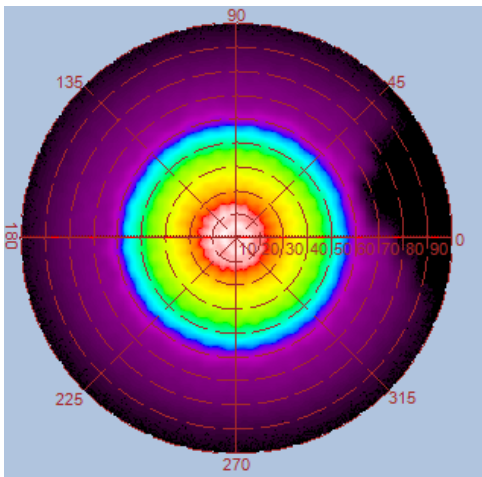
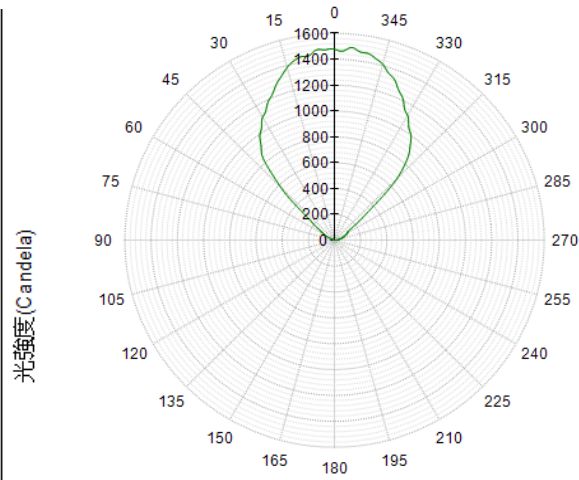
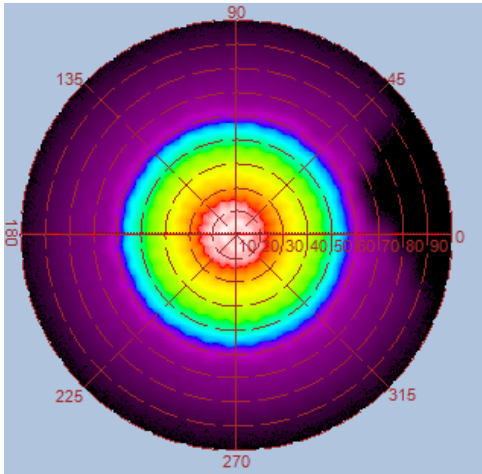

Height	E Avg.	E Max.	Diameter
1.0M	979 Lx	1931 Lx	188 cm
2.0M	225 Lx	399 Lx	376 cm
3.0M	97 Lx	166 Lx	564 cm
4.0M	54 Lx	91 Lx	752 cm
5.0M	34 Lx	57 Lx	940 cm

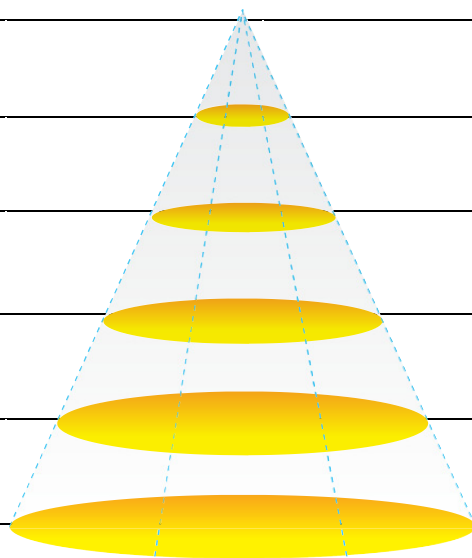

GL-BL30-NW / CCT : 4000K (Frosted Cover-with lampshade)

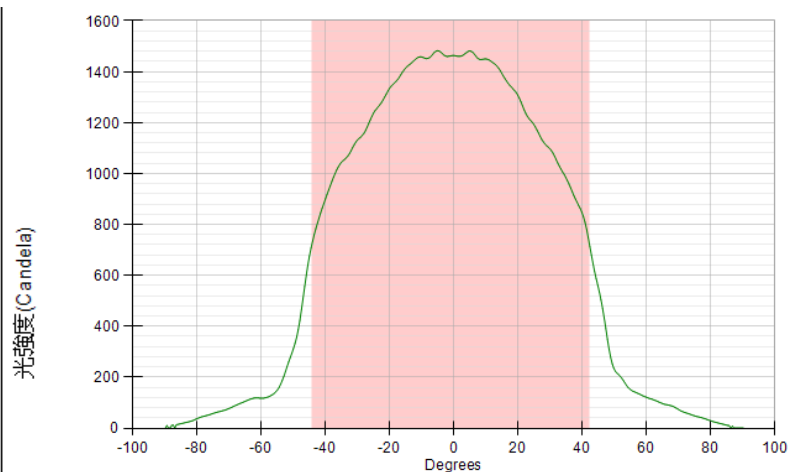
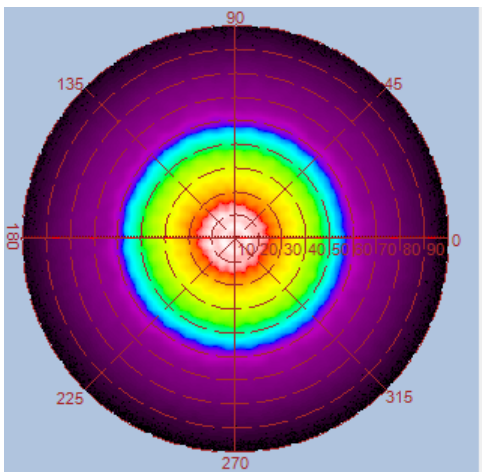
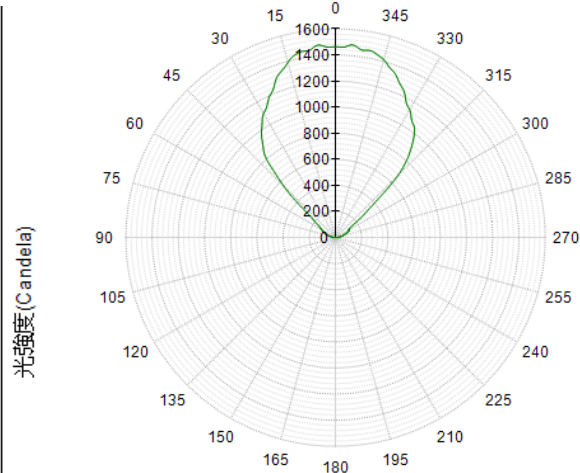
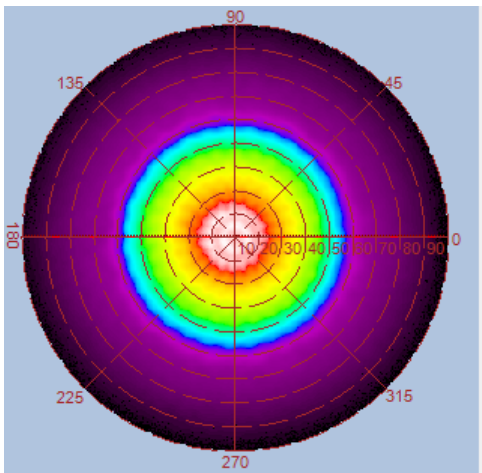

Angle= 87.0 Deg

Height	E Avg.	E Max.	Diameter
1.0M	1003 Lx	1985 Lx	189 cm
2.0M	230 Lx	406 Lx	379 cm
3.0M	100 Lx	170 Lx	569 cm
4.0M	55 Lx	92 Lx	759 cm
5.0M	35 Lx	59 Lx	948 cm

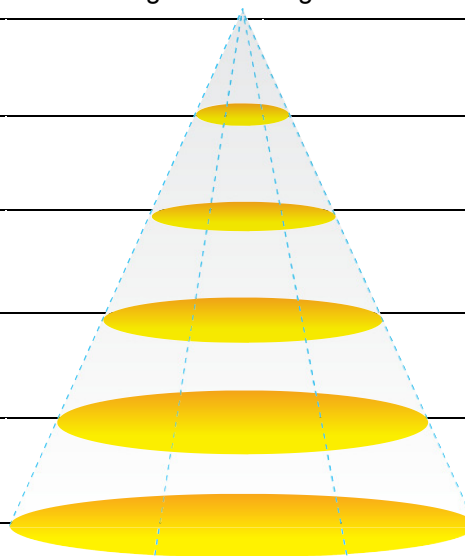

GL-BL30-CW / CCT : 5000K (Frosted Cover-with lampshade)

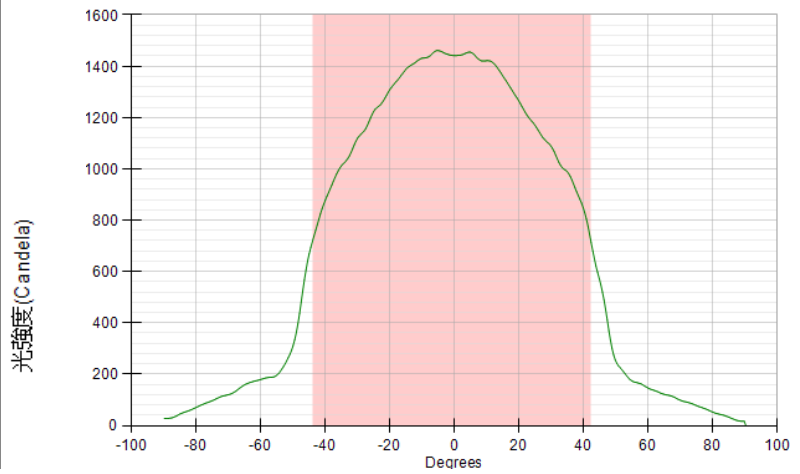
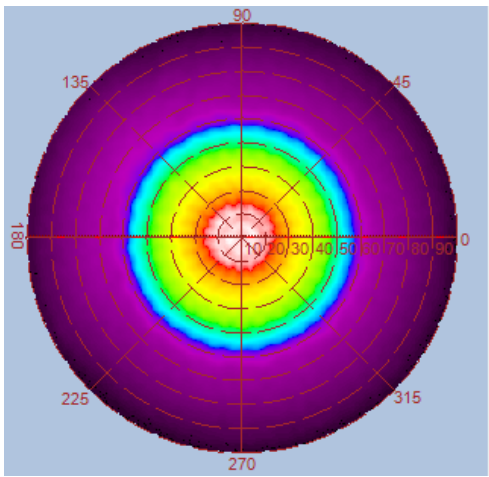
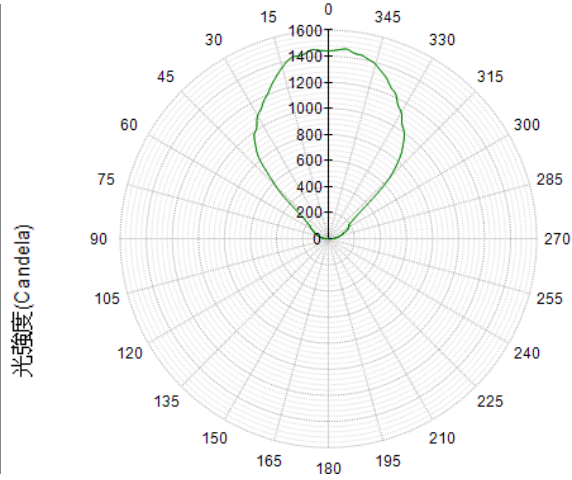
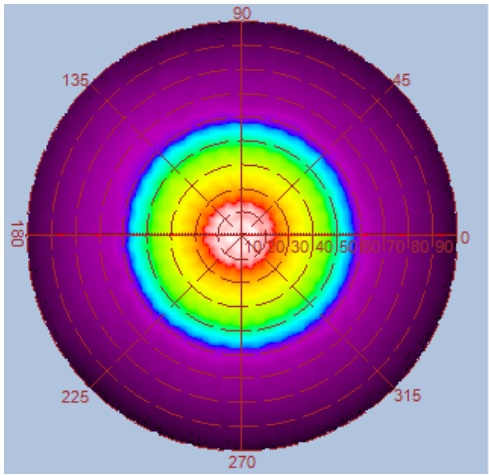

Height	E Avg.	E Max.	Diameter
1.0M	1034 Lx	2027 Lx	188 cm
2.0M	237 Lx	417 Lx	376 cm
3.0M	102 Lx	174 Lx	564 cm
4.0M	57 Lx	95 Lx	752 cm
5.0M	36 Lx	60 Lx	940 cm

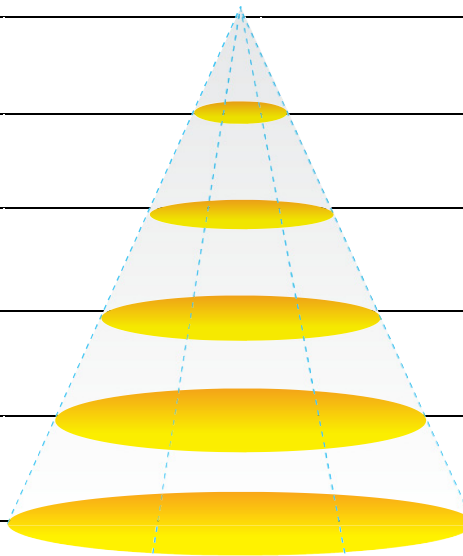

Luminous Intensity Distribution Diagram

GL-BL30-WW / CCT : 3000K (Frosted Cover-without lampshade)

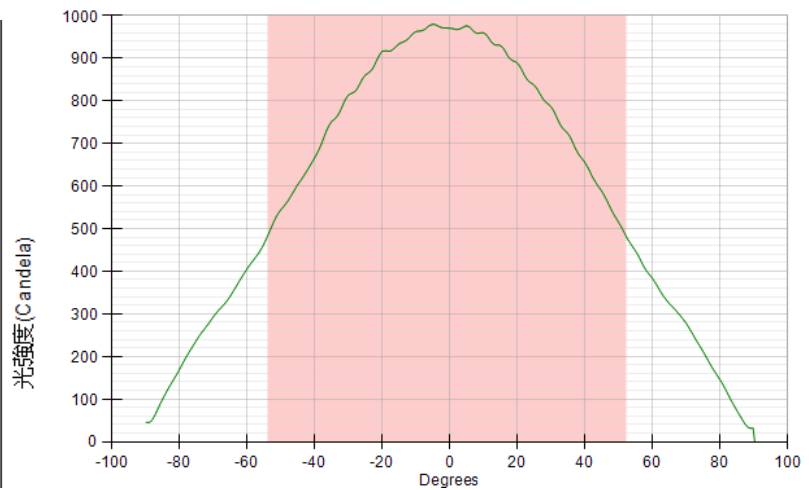
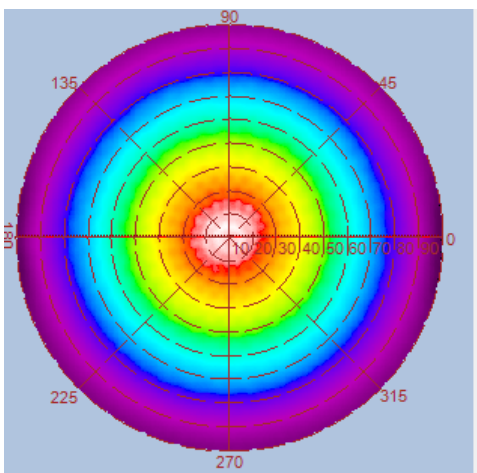
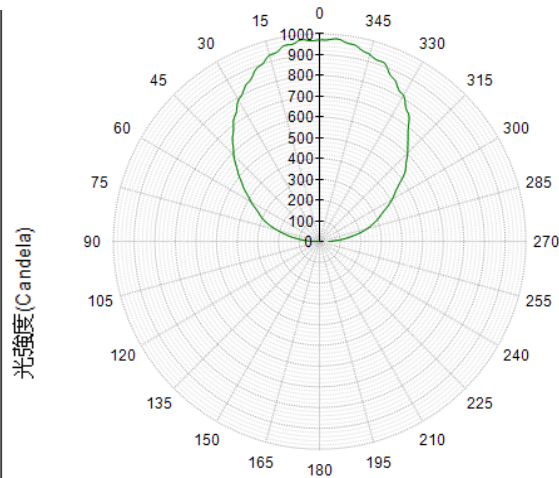
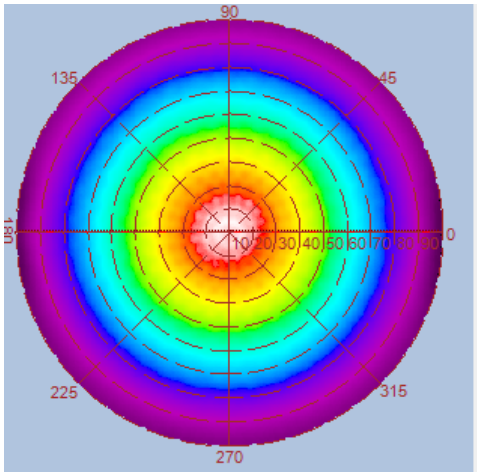

Height	E Avg.	E Max.	Diameter
1.0M	511 Lx	1063 Lx	267 cm
2.0M	123 Lx	252 Lx	535 cm
3.0M	54 Lx	109 Lx	803 cm
4.0M	30 Lx	61 Lx	1071 cm
5.0M	19 Lx	38 Lx	1339 cm

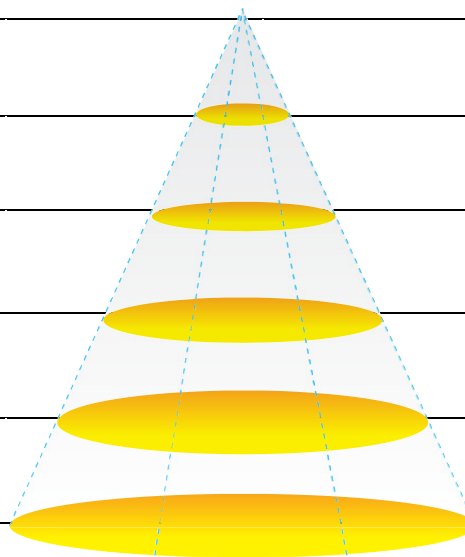

GL-BL30-NW / CCT : 4000K (Frosted Cover-without lampshade)

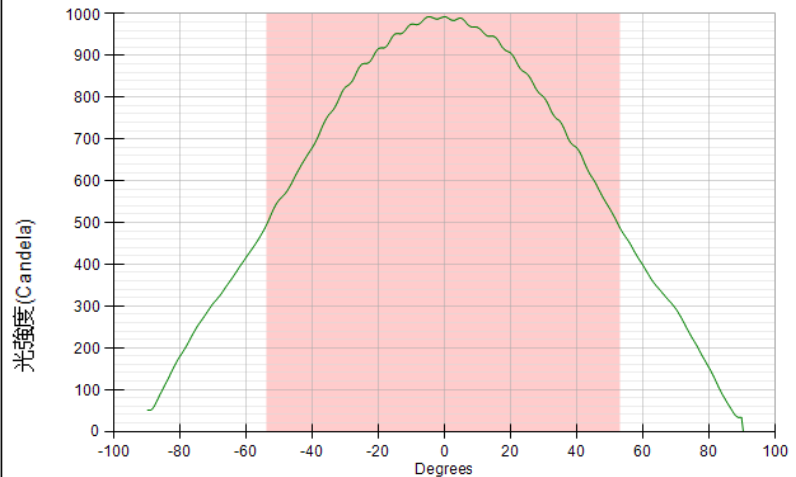
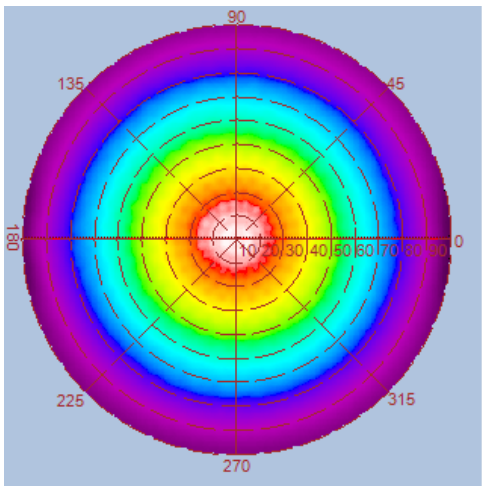
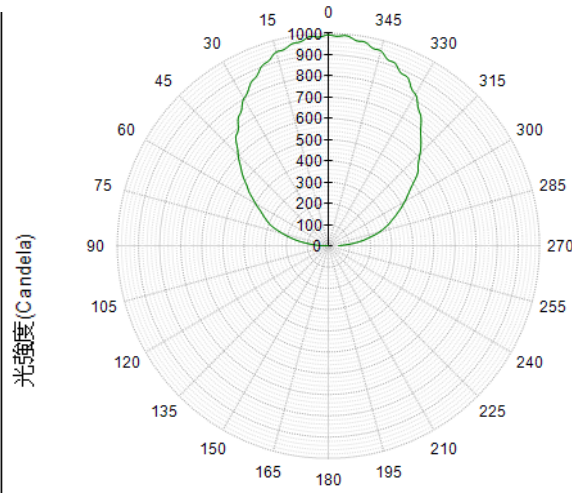
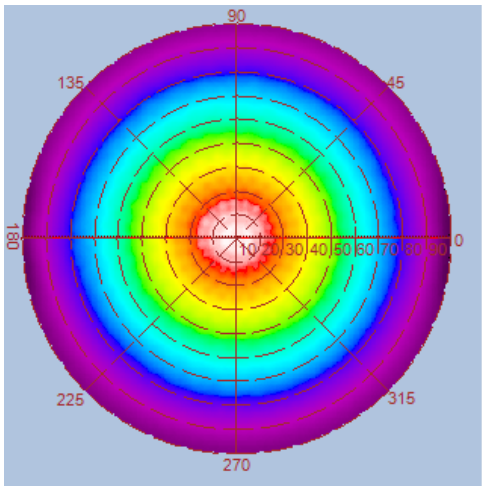

Height	E Avg.	E Max.	Diameter
1.0M	515 Lx	1078 Lx	270 cm
2.0M	124 Lx	255 Lx	540 cm
3.0M	54 Lx	111 Lx	810 cm
4.0M	30 Lx	62 Lx	1081 cm
5.0M	19 Lx	39 Lx	1351 cm

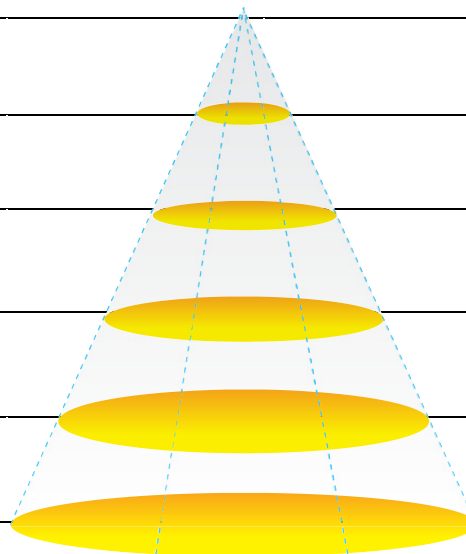

GL-BL30-CW / CCT : 5000K (Frosted Cover-without lampshade)

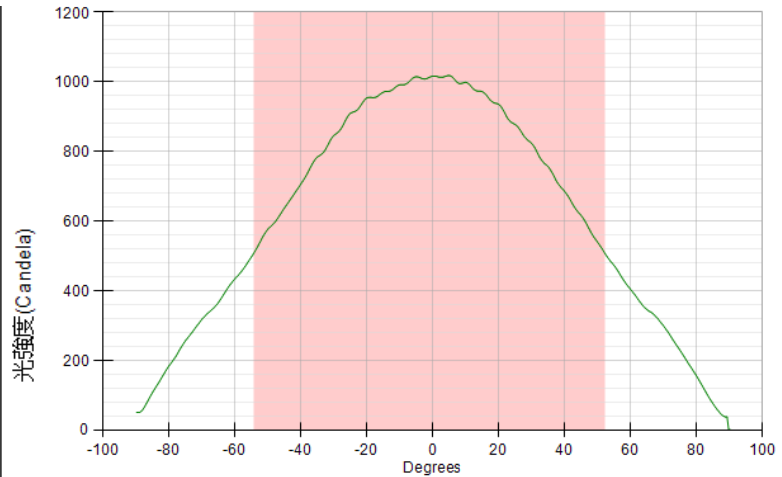
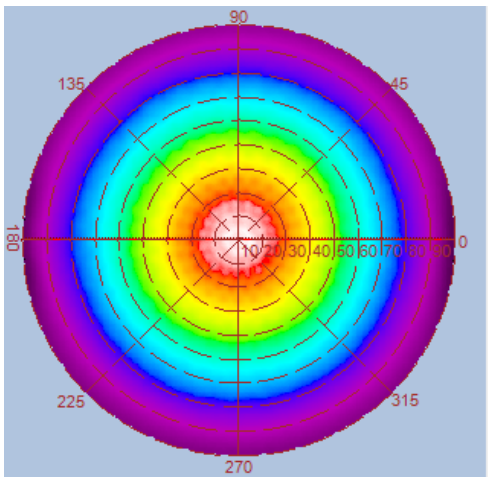
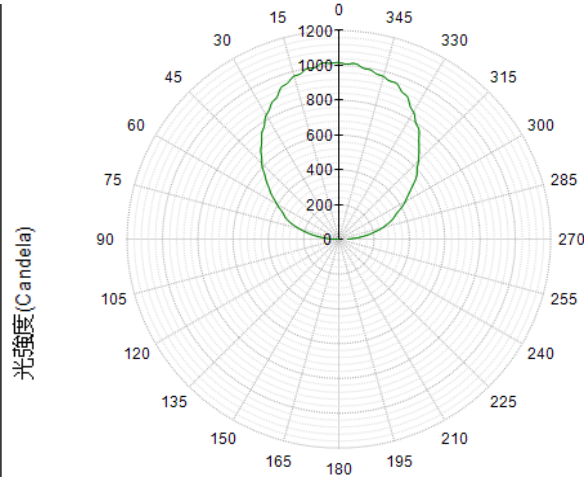
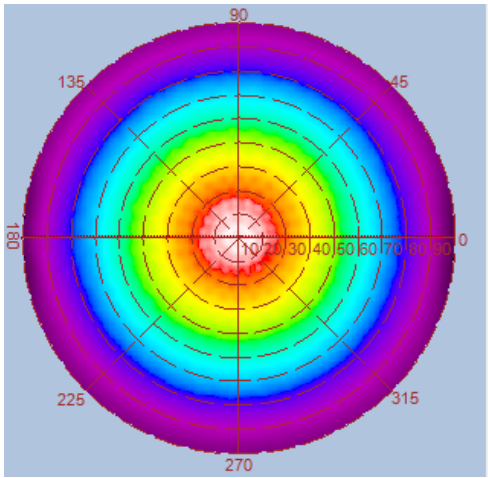

Height	E Avg.	E Max.	Diameter
1.0M	530 Lx	1108 Lx	270 cm
2.0M	127 Lx	261 Lx	540 cm
3.0M	56 Lx	113 Lx	810 cm
4.0M	31 Lx	63 Lx	1081 cm
5.0M	20 Lx	40 Lx	1351 cm

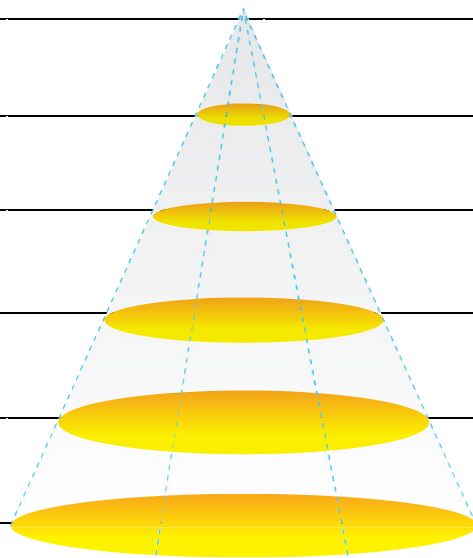

Suggestion installation length:

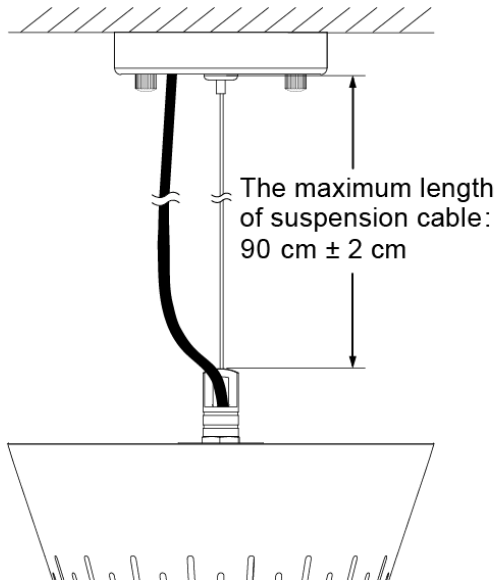

The cable actual length:

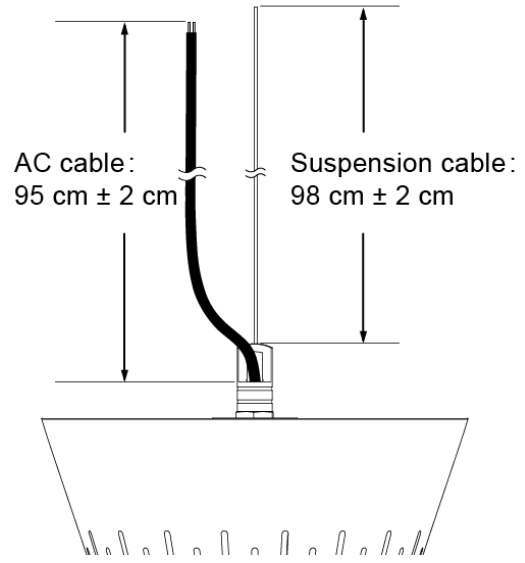

Photograph



Frosted Cover without lampshade