



Features

- Indoor & outdoor use
- High power efficiency > 80%
- LED chips by Philips Lumileds
- Long life span: >30,000 hours
- Ideal replacement for mercury lamps
- Eco-friendly: No UV, no IR, & no mercury









Specifications

Type	GL-FL30S-V2-WW	GL-FL30S-V2-CW
Energy Used	28 W	
Rated Life	30,000 Hours	
Input Voltage	100-240V AC	
CCT (color)	3000K	5700K
Luminous Flux	1570 lm	1900 lm
System Efficacy	56 lm/W	68 lm/W
CRI	85	70
Beam Angle	30° / 60°	
Dimension	180 x 192 x 117 mm	
IP Rating	IP54	
Operation Temperature	-20°C ~ +40°C	
Net Weight	1.4 kg	
Package	6 Box/Carton	

Outline / Dimension

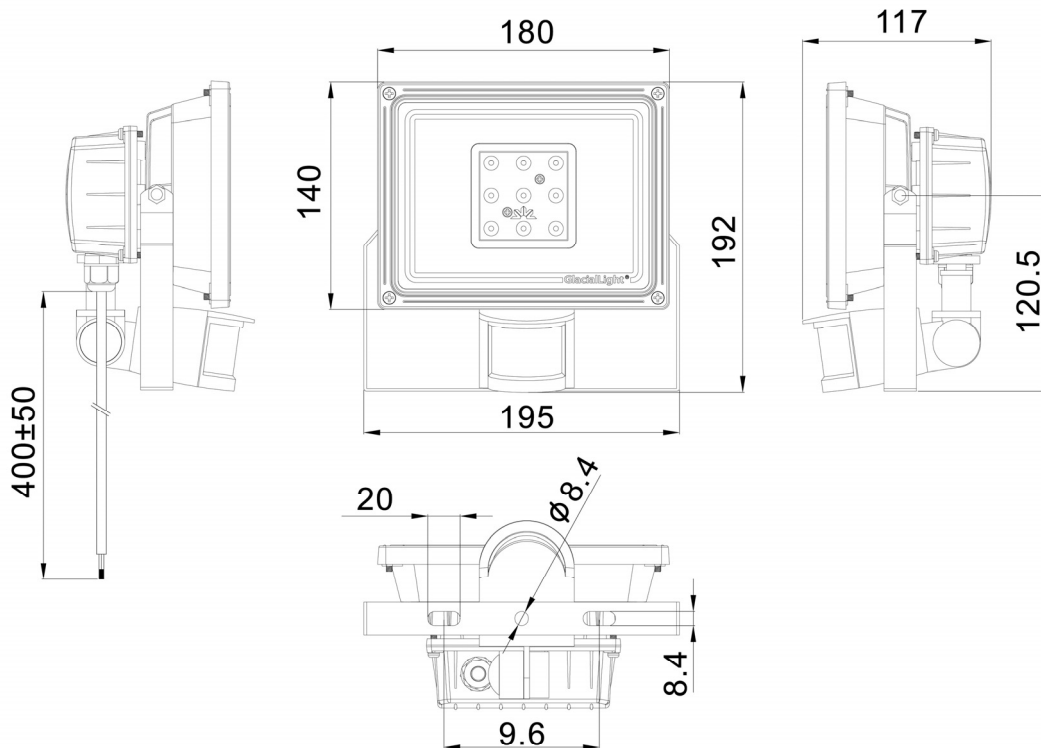

※ UNIT: mm ※ Philips Lumileds LED

Luminous Intensity Distribution Diagram

GL-FL30S-V2-WW-30D/ CCT: 3000K

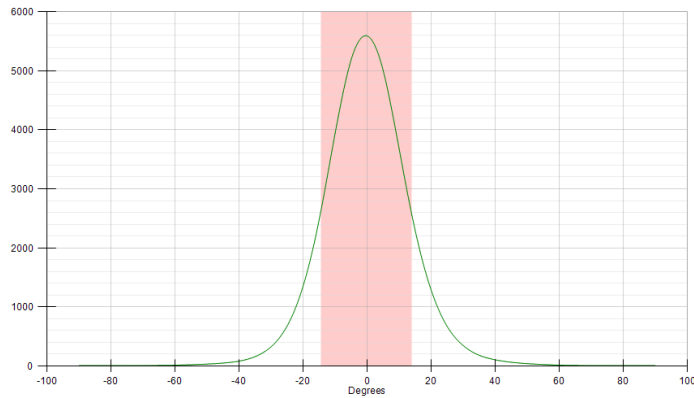
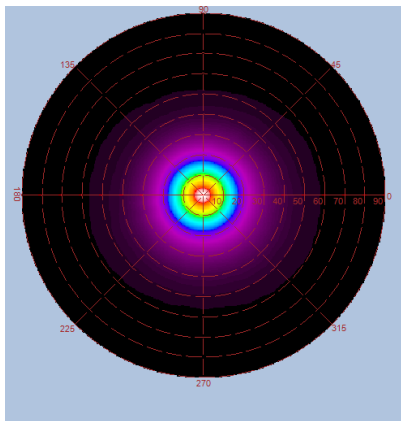
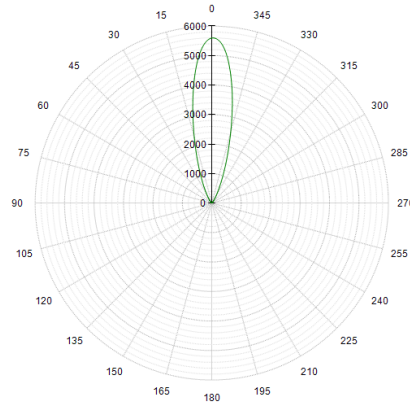
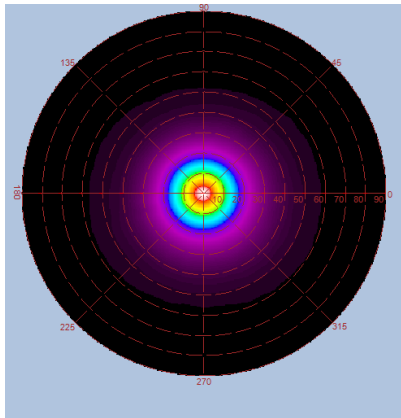

Height	E Max.	Diameter
1.0M	4255 Lx	0.508m
2.0M	1073 Lx	1.016m
3.0M	478 Lx	1.524m
4.0M	269.2 Lx	2.032m
5.0M	172.1 Lx	2.540m

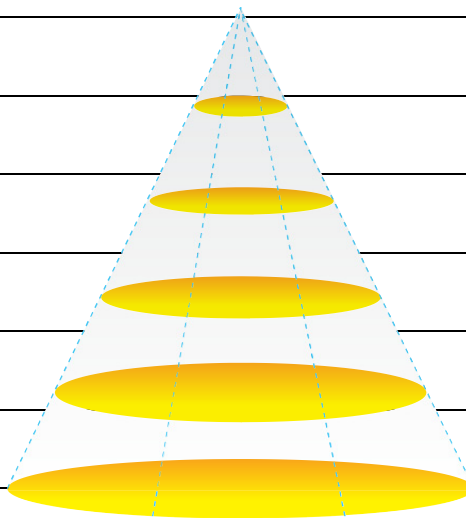

Luminous Intensity Distribution Diagram

GL-FL30S-V2-WW-60D/ CCT: 3000K

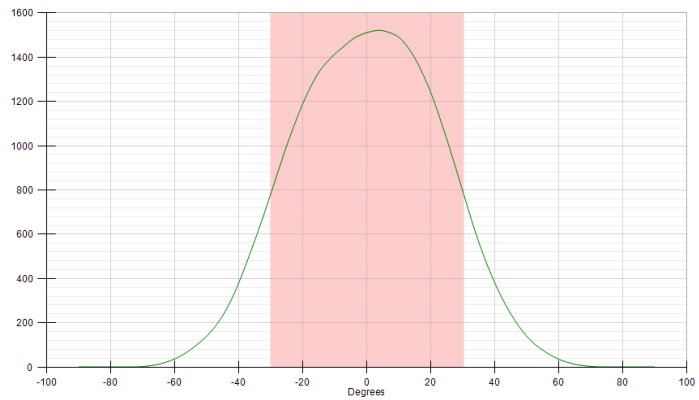
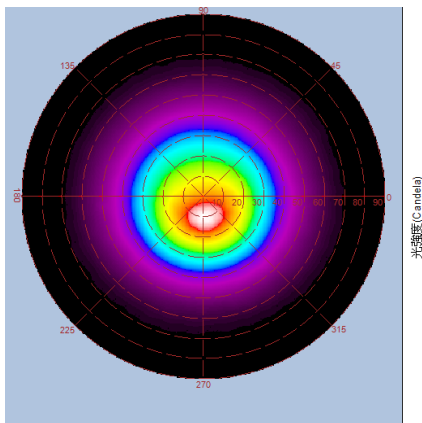
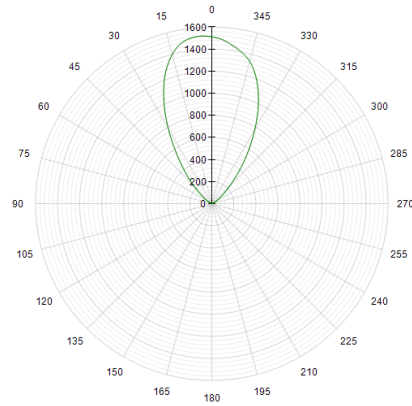
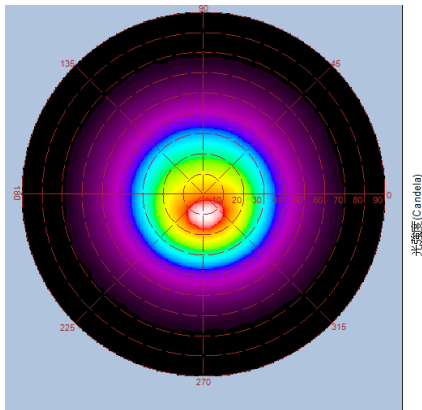

Height	E Max.	Diameter
1.0M	1083 Lx	1.466m
2.0M	273.4 Lx	2.333m
3.0M	121.9 Lx	3.499m
4.0M	68.7 Lx	4.665m
5.0M	43.9 Lx	5.832m

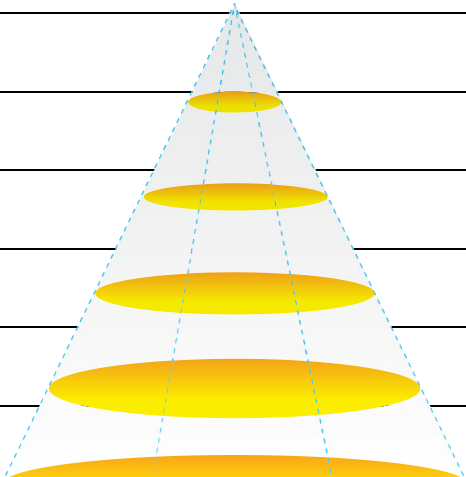

Luminous Intensity Distribution Diagram

GL-FL30S-V2-CW-30D/ CCT: 5700K

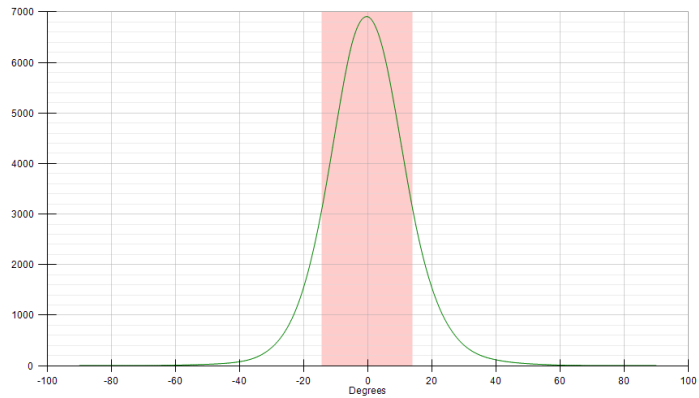
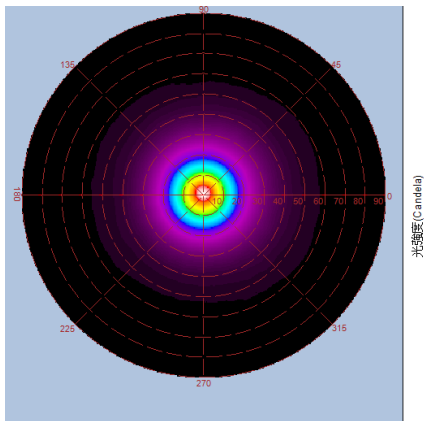
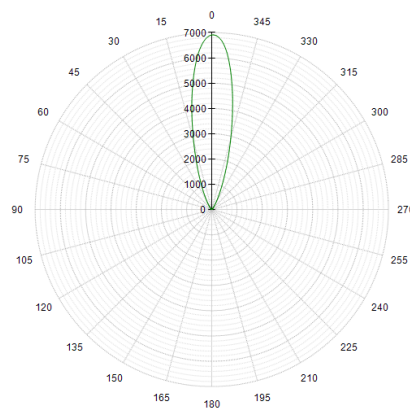
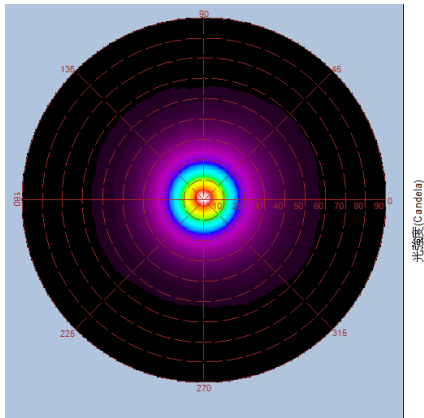

Height	E Max.	Diameter
1.0M	7417 Lx	0.508m
2.0M	1820 Lx	1.016m
3.0M	793 Lx	1.524m
4.0M	443 Lx	2.032m
5.0M	281 Lx	2.540m

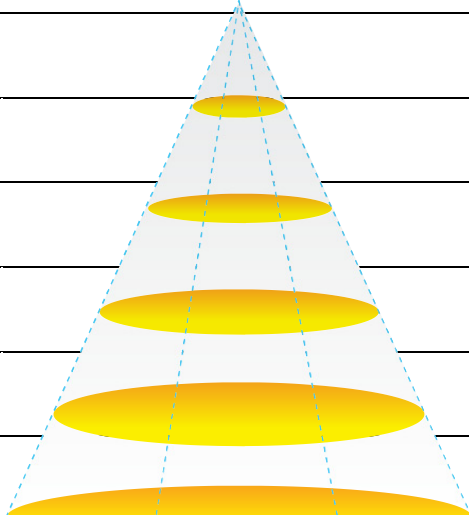

Luminous Intensity Distribution Diagram

GL-FL30S-V2-CW-60D/ CCT: 5700K

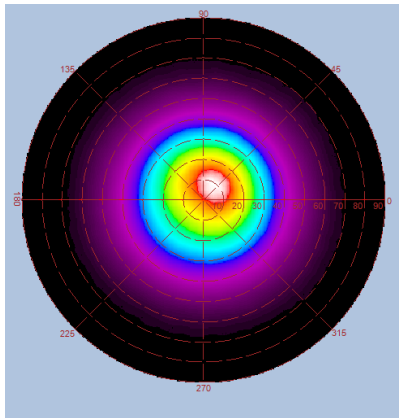

光强度 (Candela)

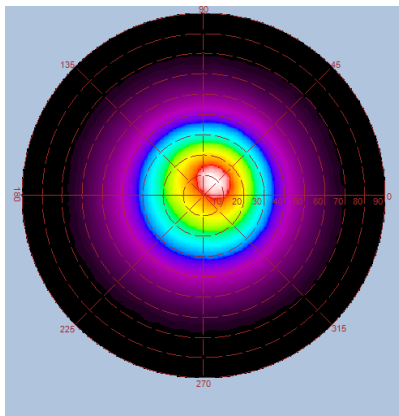
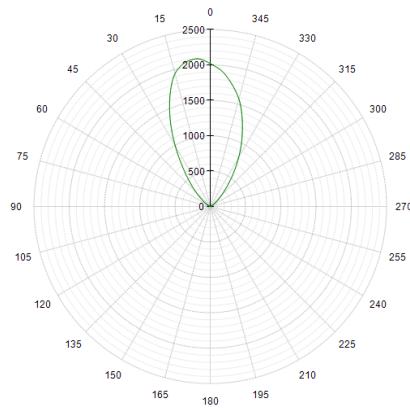

光强度 (Candela)

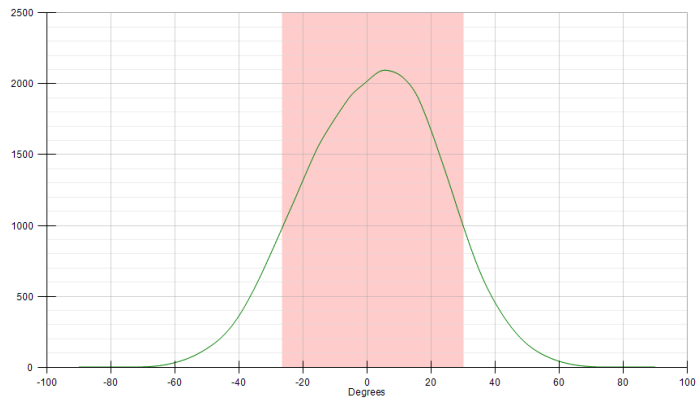

Height	E Max.	Diameter
1.0M	1559 Lx	1.075m
2.0M	379 Lx	2.149m
3.0M	167.3 Lx	3.224m
4.0M	93.6 Lx	4.298m
5.0M	59.8 Lx	5.373m

