



Features

- Indoor & outdoor use
- High power efficiency > 80%
- LED chips by Philips Lumileds
- Long life span: >30,000 hours
- Ideal replacement for mercury lamps
- Eco-friendly: No UV, no IR, & no mercury



Specifications

Type	GL-FL12-WW	GL-FL12-CW
Energy Used	13 W	
Rated Life	30,000 Hours	
Input Voltage	100-277V AC	
Power Factor (PF)	0.85 at 120V AC, 0.75 at 240V AC	
CCT (color)	3000K	5700K
Luminous Flux	650 lm	750 lm
System Efficacy	50 lm/W	57 lm/W
CRI	85	70
Beam Angle	30° / 60°	
Dimension	115 x 85 x 85 mm	
IP Rating	IP66	
Operation Temperature	- 20°C ~ + 40°C	
Net Weight	550 g	
Package	12 Box/Carton	

Outline / Dimension

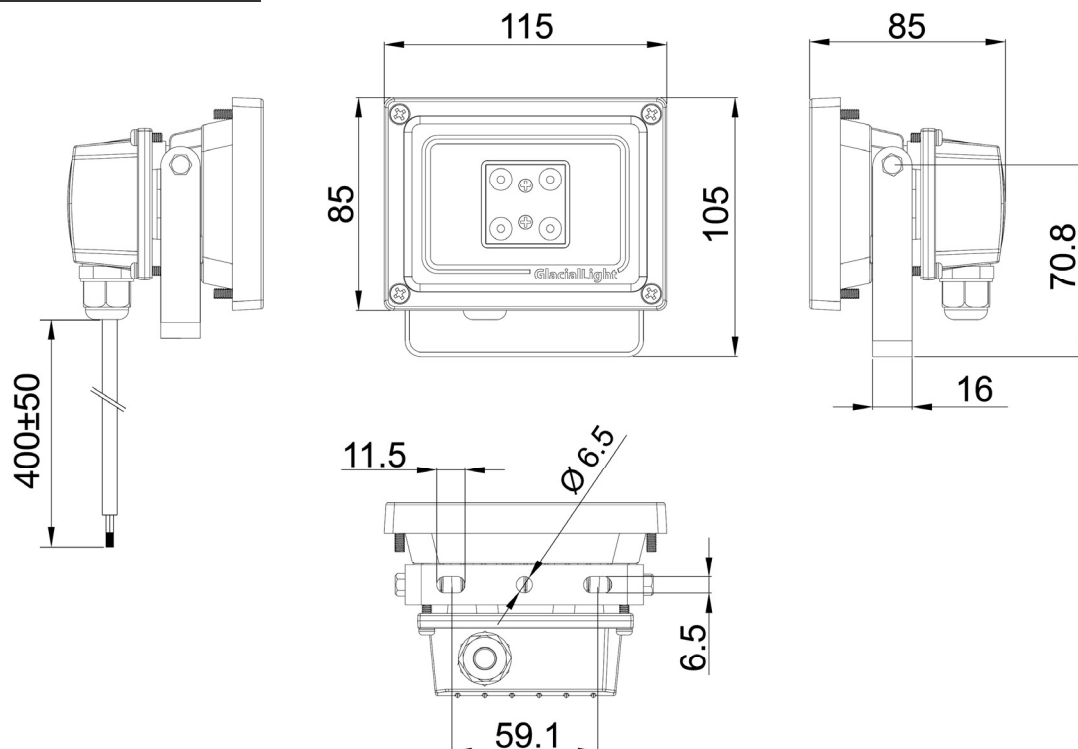

※ UNIT: mm

※ Philips Lumileds LED

Luminous Intensity Distribution Diagram

GL-FL12-WW-30D/ CCT: 3000K

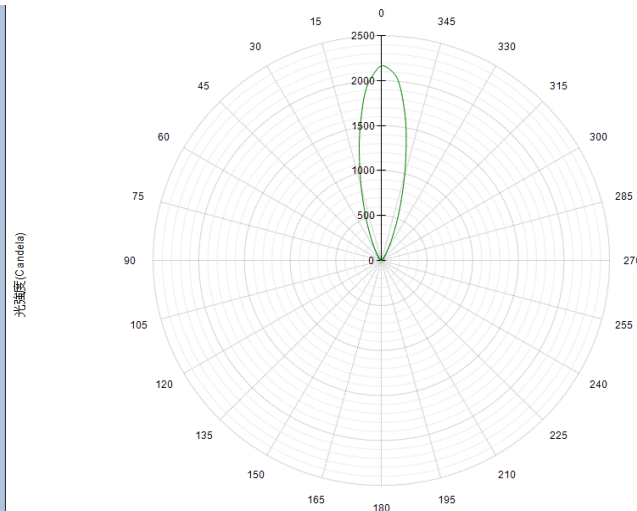
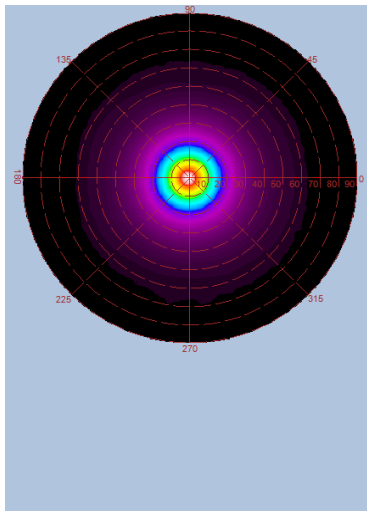
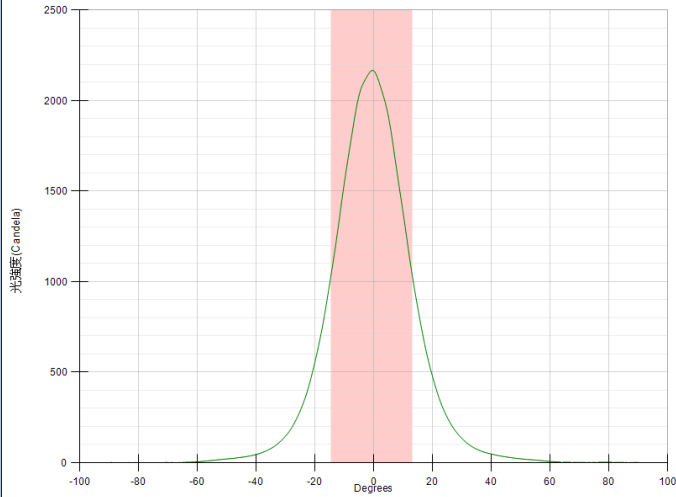
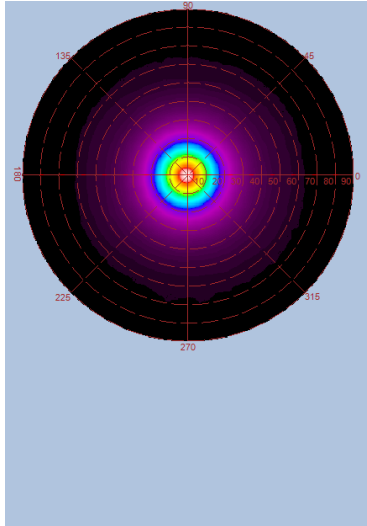

Height	E Max.	Diameter
1.0M	2356.0 Lx	0.489 m
2.0M	561.0 Lx	0.979 m
3.0M	245.3 Lx	1.468 m
4.0M	137.4 Lx	1.958 m
5.0M	86.9 Lx	2.447 m

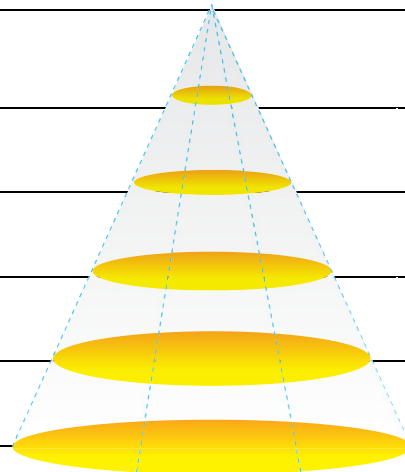

Luminous Intensity Distribution Diagram

GL-FL12-WW-60D/ CCT: 3000K

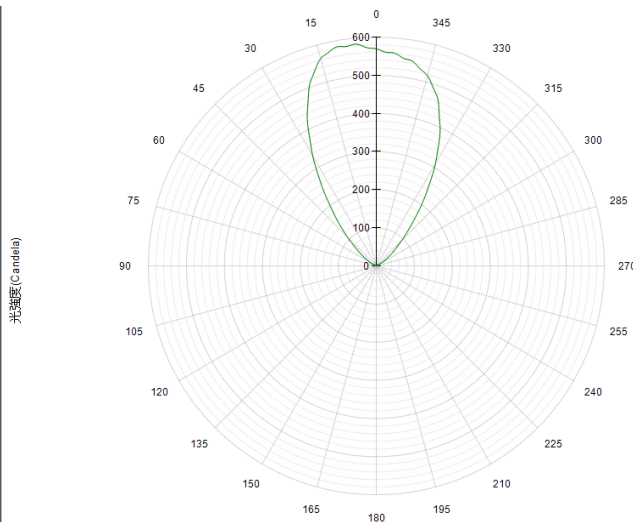
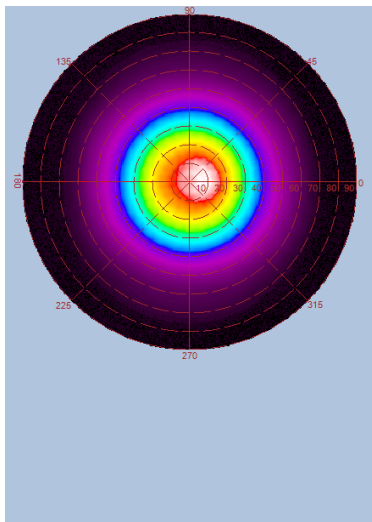
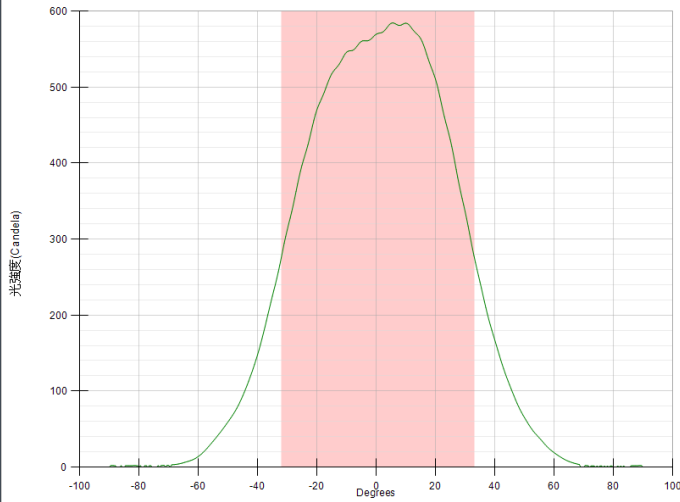
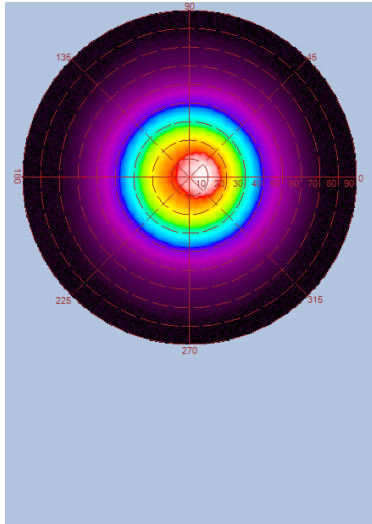

Height	E Max.	Diameter
1.0M	624.0 Lx	1.274 m
2.0M	147.8 Lx	2.548 m
3.0M	65.0 Lx	3.822 m
4.0M	36.3 Lx	5.097 m
5.0M	23.1 Lx	6.371 m

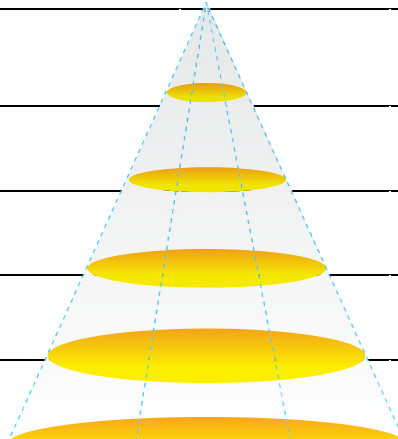

Luminous Intensity Distribution Diagram

GL-FL12-CW-30D/ CCT:5700K

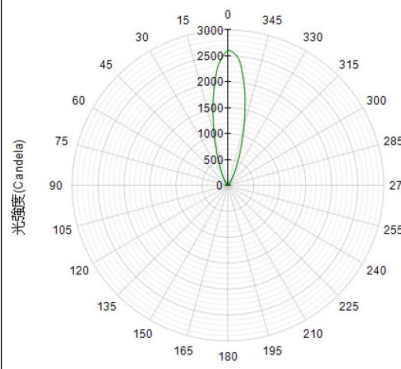
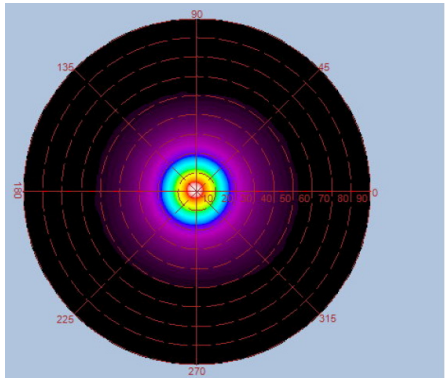
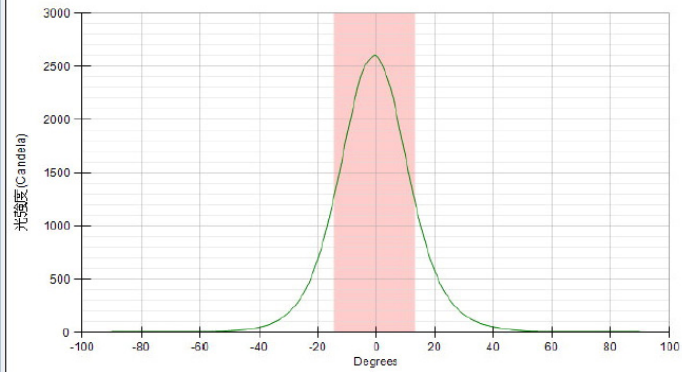
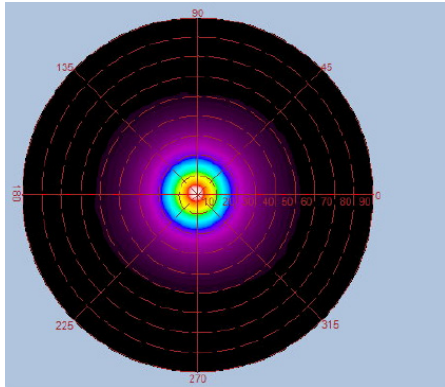

Height	E Max.	Diameter
1.0M	2512 Lx	49cm
2.0M	628 Lx	98cm
3.0M	279 Lx	147cm
4.0M	157 Lx	196cm
5.0M	100 Lx	245cm

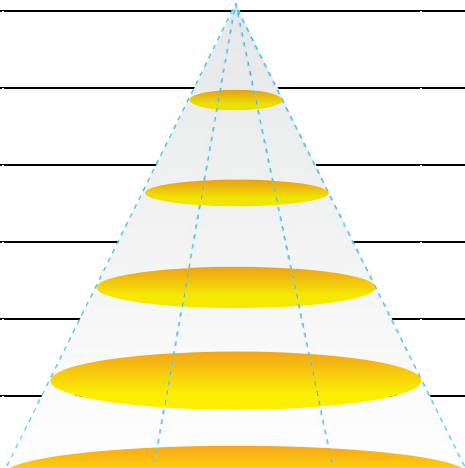

Luminous Intensity Distribution Diagram

GL-FL12-CW-60D/ CCT: 5700K

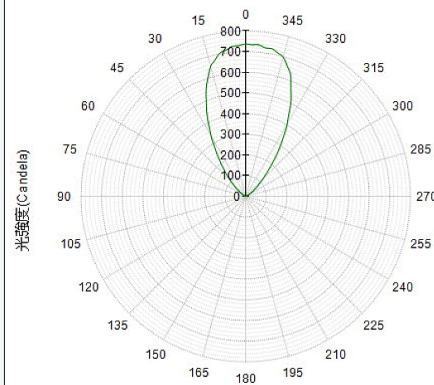
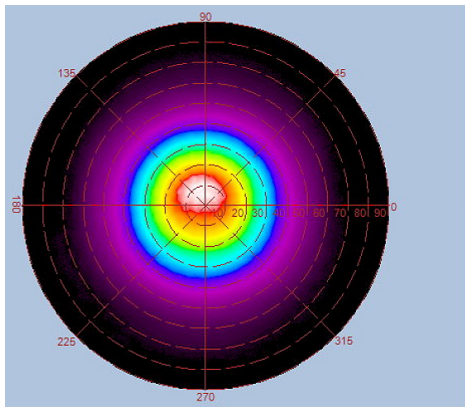
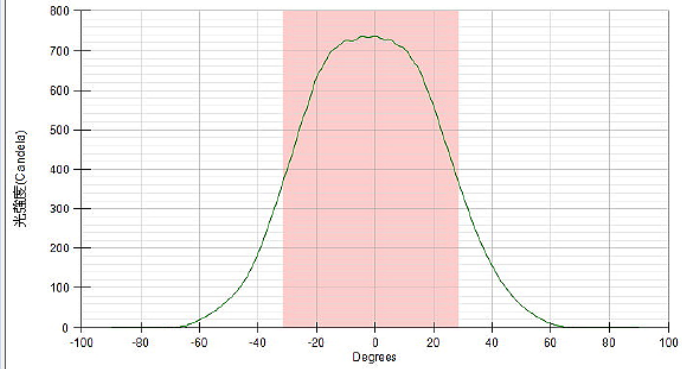
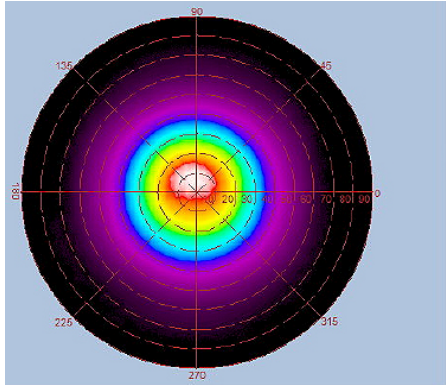

Height	E Max.	Diameter
1.0M	735 Lx	115cm
2.0M	184 Lx	230cm
3.0M	82 Lx	345cm
4.0M	46 Lx	460cm
5.0M	29 Lx	575cm

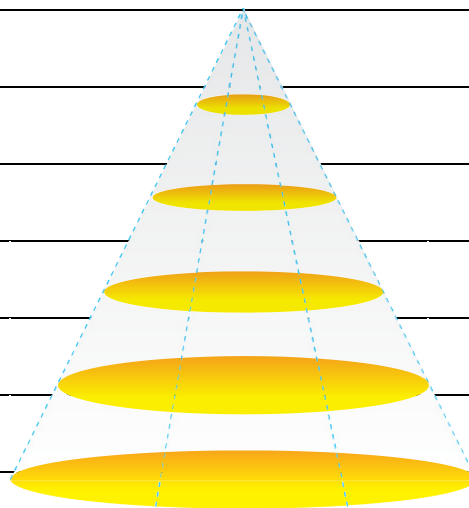

Mounting Kit

